

ULTRAMETER II™

Operation Manual

MODELS 6P & 4P

**MYRON L
COMPANY**

Water Quality Instrumentation
Accuracy • Reliability • Simplicity

11 Nov 08

Instrument Illustration

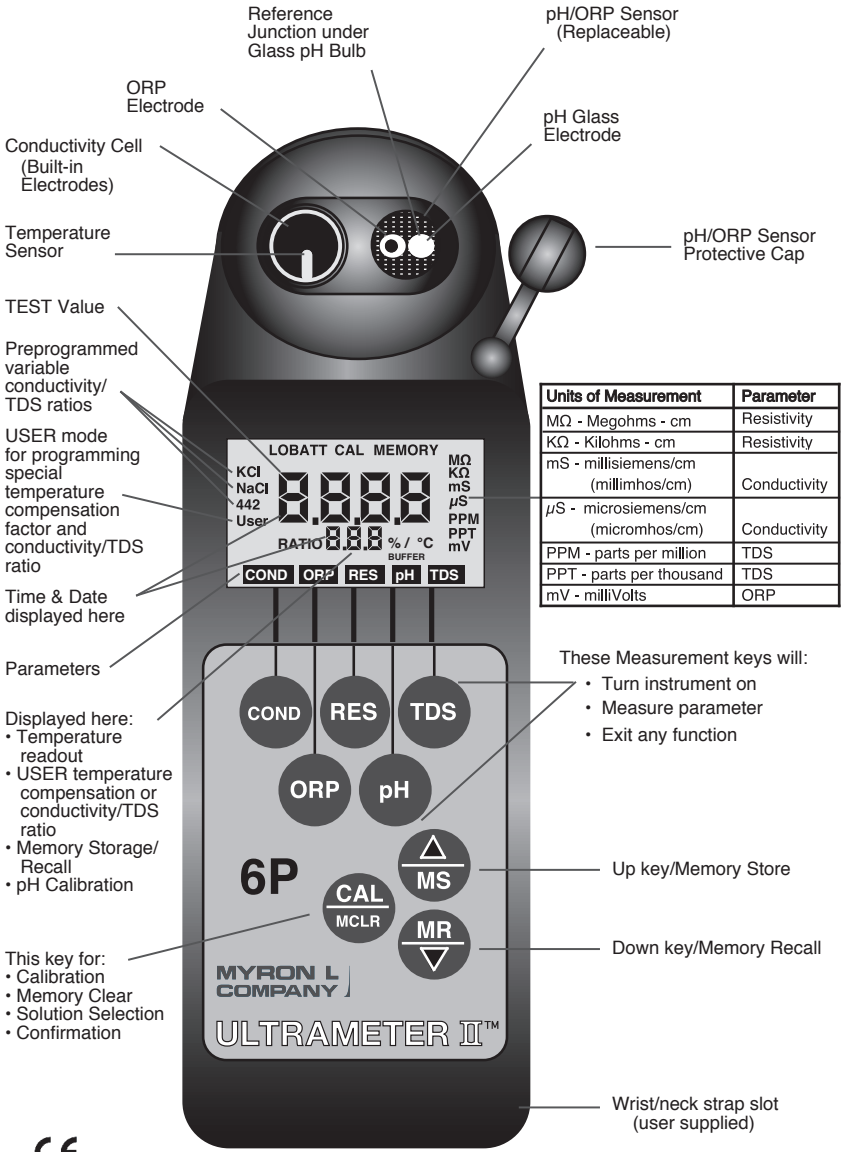

Units of Measurement	Parameter
MΩ - Megohms - cm	Resistivity
KΩ - Kiloohms - cm	Resistivity
mS - millisiemens/cm (millimhos/cm)	Conductivity
μS - microsiemens/cm (micromhos/cm)	Conductivity
PPM - parts per million	TDS
PPT - parts per thousand	TDS
mV - millivolts	ORP

- These Measurement keys will:
- Turn instrument on
 - Measure parameter
 - Exit any function

- This key for:
- Calibration
 - Memory Clear
 - Solution Selection
 - Confirmation



MODEL 6P Shown

For detailed explanations see Table of Contents

I. **INTRODUCTION**

Thank you for selecting the feature-packed Ultrameter II™, one of the Myron L Company's latest in an increasing line of instruments utilizing advanced microprocessor-based circuitry and SMT manufacturing processes. This circuitry makes the instrument extremely accurate, reliable and very easy to use.

The Ultrameter II incorporates several new features including a clock with time and date, an increased memory of up to 100 locations with time and date stamp, the ability of the user to adjust the timeout "Auto OFF", and enhanced performance. See Features and Specifications on pages 2 & 3.

The most exciting new feature is data logging with the ability to download the memory or stored test data with its corresponding time and date. This feature allows the user to create spreadsheets and graphs with ease, and quickly and accurately manipulate data more effectively. The optional uDock™ and software is compatible with most computers using either Microsoft Windows XP or 2000™, or Macintosh OS9.2 or OS X™. The data may be imported into a variety of spreadsheet formats like Microsoft Excel CSV™.

Please Note: Although the Myron L Company has performed extensive testing, we can not guarantee compatibility of all applications and formats. We suggest testing your application and format for compatibility before relying on it.

For your convenience, on the bottom side of your Ultrameter II is a brief set of instructions. A waterproof pocket sized card with abbreviated instructions is also included with the instrument.

Special note Conductivity, resistivity, and TDS require mathematical correction to 25°C values (ref. Temperature Compensation, pg. 37). On the left of the Ultrameter II's liquid crystal display is shown an indicator of the salt solution characteristic used to model temperature compensation of conductivity and its TDS conversion. The indicator may be KCl, NaCl, 442™ or USER. Selection affects the temperature correction of conductivity, and the calculation of TDS from compensated conductivity (ref. Conductivity Conversion to Total Dissolved Solids (TDS), pg. 40). The selection can affect the reported conductivity of hot or cold solutions, and will change the reported TDS of a solution. Generally, using KCl for conductivity, NaCl for resistivity, and 442 (Natural Water characteristic) for TDS will reflect present industry practice for standardization. This is how your instrument, as shipped from the factory, is set to operate. For use in sea water desalination for example, both the conductivity and TDS may easily be changed to NaCl.

II. **FEATURES and SPECIFICATIONS**

A. Features

- Superior resolution 4 digit LCD displays full 9999 $\mu\text{S/ppm}$.
- Accuracy of BETTER than $\pm 1\%$ of reading in a handheld instrument.
- All electrodes are internal for maximum protection.
- Improved 4 electrode sensor technology.
- Waterproof to 1 meter/3 feet.
- Autoranging conductivity/TDS/resistivity.
- Prompts for easy pH calibration (6P).
- Factory calibrations stored in microprocessor.
- 3 conductivity/TDS solution conversions preprogrammed into microprocessor.
- USER mode feature allows:
 - Programming your own cond/TDS conversion factor.
 - Programming your own temperature compensation factor.
 - Disabling temperature compensation.
- Real Time Clock with Time and Date.
- Data Logging with TIME and DATE in memory.
- Memory stores 100 readings.
- Download capability with optional uDock™.
- User adjustable timeout "Auto OFF".

B. General Specifications

Display	4 Digit LCD
Dimensions (LxWxH)	196 x 68 x 64 mm/ 7.7 x 2.7 x 2.5 in.
Weight	352 g/12.4 oz.
Case Material	VALOX*
Cond/Res/TDS Cell Material	VALOX*
Cond/TDS Electrodes (4)	316 Stainless Steel
Cond/Res/TDS Cell Capacity	5 ml/0.2 oz.
pH/ORP Sensor Well Capacity	1,2 ml (6P)/0.04 oz.
Power	9V Alkaline Battery
Battery Life	>100 Hours/5000 Readings
Operating/Storage Temperature	0-55°C/32-132°F
Protection Ratings	IP67/NEMA 6 (waterproof to 1 meter/3 feet)

* ™ GE Corp.

Additional information is available on our website at:

www.myronl.com



C. Specification Chart

	pH (6P)	ORP (6P)	Conductivity	TDS	Resistivity	Temperature
Ranges	0-14 pH	±999 mV	0-9999 μ S/cm 10-200 mS/cm in 5 autoranges	0-9999 ppm 10-200 ppt in 5 autoranges	10K Ω - 30M Ω	0-71 °C 32 - 160 °F
Resolution	±0.01 pH	±1 mV	0.01 (<100 μ S) 0.1 (<1000 μ S) 1.0 (<10 mS) 0.01 (<100 mS) 0.1 (<200 mS)	0.01 (<100 ppm) 0.1 (<1000 ppm) 1.0 (<10 ppt) 0.01 (<100 ppt) 0.1 (<200 ppt)	0.01 (<100 K Ω) 0.1 (<1000 K Ω) 0.1 (>1 M Ω)	0.1 °C/F
Accuracy	±0.01 pH	±1 mV	±1% of reading	±1% of reading	±1% of reading	±0.1 °C
Auto Temperature Compensation	0-71 °C 32 - 160 °F		0-71 °C 32 - 160 °F	0-71 °C 32 - 160 °F	0-71 °C 32 - 160 °F	
Adjustable Temperature Compensation			0 - 9.99%/ °C	0 - 9.99%/ °C	0 - 9.99%/ °C	
Cond/TDS Ratios Preprogrammed			KCl, NaCl, 442™			
Adjustable Cond/TDS Ratio Factor			0.20 - 7.99			

D. Warranty/Service

The Myron L Ultrameter II, excluding the pH/ORP sensor (6P), has a Two (2) Year Limited Warranty. The pH/ORP sensor (6P) has a Six (6) Month Limited Warranty for materials and workmanship. If an instrument fails to operate properly, see Troubleshooting Chart, pg. 34. The battery and pH/ORP sensor are user-replaceable. For other service, return the instrument prepaid to the Myron L Company.

Myron L COMPANY
2450 Impala Drive
Carlsbad, CA 92010-7226 USA
+1-760-438-2021
E-Mail: info@myronl.com
techquestions@myronl.com
www.myronl.com

If, in the opinion of the factory, failure was due to materials or workmanship, repair or replacement will be made without charge. A reasonable service charge will be made for diagnosis or repairs due to normal wear, abuse or tampering. This warranty is limited to the repair or replacement of the Ultrameter II only. The Myron L Company assumes no other responsibility or liability.

E. Ultrameter II Models

ULTRAMETER II MODELS	4P	6P
PARAMETERS	Conductivity/TDS Resistivity/Temp.	Conductivity/TDS/pH Resistivity/ORP/Temp.

MADE IN USA

TABLE OF CONTENTS

Instrument Illustration	i
I. INTRODUCTION	1
II. FEATURES and SPECIFICATIONS.	2
A. Features	2
B. General Specifications	2
C. Specification Chart	3
D. Warranty/Service	3
E. Ultrameter II Models	3
III. RULES of OPERATION	7
A. Operation	7
B. Characteristics of the Keys	7
C. Operation of the Keys	7
1. Measurement Keys in General	7
2. COND, RES and TDS Keys	7
3. pH and ORP Keys (6P)	8
4. CAL/MCLR Key	8
5. UP or DOWN Keys.	9
IV. AFTER USING the Ultrameter II.	9
A. Maintenance of the Conductivity Cell	9
B. Maintenance of the pH/ORP Sensor (6P).	9
V. SPECIFIC RECOMMENDED MEASURING PROCEDURES.	9
A. Measuring Conductivity/Total Dissolved Solids.	9
B. Measuring Resistivity	10
C. Measuring pH (6P)	10
D. Measuring ORP (6P).	10
VI. SOLUTION SELECTION.	11
A. Why Solution Selection is Available	11
B. The 4 Solution Types	11
C. Calibration of Each Solution Type	11
D. Procedure to Select a Solution	11
E. Application of USER Solution Type.	12
1. User Programmable Temperature Compensation (Tempco)	12
2. Disabling Temperature Compensation	13
3. User Programmable Conductivity to TDS Ratio	13
VII. CALIBRATION	14
A. Calibration Intervals	14
B. Rules for Calibration of the Ultrameter II	14
1. Calibration Steps	14
2. Calibration Limits	15

	C. Calibration Procedures	15
	1. Conductivity or TDS Calibration	15
	2. User Calibration Conductivity/TDS	15
	3. Resistivity Calibration	16
	4. Reloading Factory Calibration	16
	5. pH Calibration (6P)	17
	6. ORP Calibration (6P)	19
	7. Temperature Calibration	19
VIII.	CALIBRATION INTERVALS	19
	A. Suggested Intervals.	19
	B. Calibration Tracking Records	20
	C. Conductivity, RES, TDS Practices.	20
	D. pH and ORP Practices (6P)	20
IX.	MEMORY	21
	A. Memory Storage	21
	B. Memory Recall.	21
	C. Clearing a Record/Memory Clear	21
X.	TIME and DATE	22
	A. Setting TIME	22
	B. Setting DATE	23
	C. DATE FORMAT “US & International (Int)”	24
XI.	TEMPERATURE FORMAT “Centigrade & Fahrenheit”	24
XII.	TOTAL RETURN to FACTORY SETTINGS	25
XIII.	CELL CHECK	26
XIV.	AUTO OFF	26
XV.	USER MODE CALIBRATION LINC™ FUNCTION	27
	A. Calibration of Ultrameter II for use in User Mode.	27
	B. Setting User Mode Calibration “Linc”	28
	C. Canceling User Mode Calibration “Linc”	29
XVI.	uDock™ IR DATA PORT	30
	A. Software Installation	30
	B. Hardware Setup	30
	C. Memory Stack Download.	30
XVII.	CARE and MAINTENANCE	32
	A. Temperature Extremes	32
	B. Battery Replacement	32
	C. pH/ORP Sensor Replacement (6P)	32
	D. Cleaning Sensors	32
XVIII.	TROUBLESHOOTING	34
XIX.	ACCESSORIES	36
	A. Conductivity/TDS Standard Solutions	36
	B. pH Buffer Solutions (6P)	36
	C. pH Sensor Storage Solution (6P)	36

	D. Soft Protective Carry Cases	37
	E. Hard Protective Carry Cases	37
	F. Replacement pH/ORP Sensor (6P)	37
	G. uDock™ IR Data Port Accessory Package	37
XX.	TEMPERATURE COMPENSATION (Tempco)	
	of Aqueous Solutions	37
	A. Standardized to 25°C.	37
	B. Tempco Variation	37
	C. An Example	38
	D. A Chart of Comparative Error	39
	E. Other Solutions	39
XXI.	CONDUCTIVITY CONVERSION to	
	TOTAL DISSOLVED SOLIDS (TDS)	40
	A. How it's Done	40
	B. Solution Characteristics	40
	C. When does it make a lot of difference?	41
XXII.	TEMPERATURE COMPENSATION (Tempco)	
	and TDS DERIVATION	41
	A. Conductivity Characteristics	41
	B. Finding the Tempco of an Unknown	42
	C. Finding the TDS Ratio of an Unknown	42
XXIII.	pH and ORP (6P)	43
	A. pH (6P)	43
	B. ORP/Oxidation-Reduction Potential/REDOX (6P)	45
XXIV.	SOFTWARE VERSION	46
XXV.	GLOSSARY	47
XXVI.	ADDENDUM	48
XXVII.	NOTES	49

III. **RULES of OPERATION**

A. Operation

Using the instrument is simple:

- Individual or multiple parameter readings may be obtained by filling individual sensors or entire cell cup area.
- Rinse the conductivity cell or pH/ORP sensor (6P) well with test solution 3 times and refill. Temperature and/or measurement extremes will require additional rinses for maximum accuracy.
- Press the desired measurement key to start measurement. Pressing the key again restarts the 15 second auto “off” timer.
- Note the value displayed or press the MS key to store the reading (ref. Memory Storage, pg. 21). It’s that simple!

B. Characteristics of the Keys

- Though your Ultrameter II has a variety of sophisticated options, it is designed to provide quick, easy, accurate measurements by simply pressing one key.
- All functions are performed one key at a time.
- There is no “off” key. After 15 seconds of inactivity the instrument turns itself off (60 seconds in CAL mode). User adjustable up to 75 seconds.
- Rarely is it necessary to press and *hold* a key (as in Procedure to Select a Solution, pg. 11; or Cond. or TDS Calibration, pg. 15).

C. Operation of the Keys (See Instrument Illustration on pg. i)

1. Measurement Keys in General

Any of the 5 measurement keys in the upper part of the keypad turns on the instrument in the mode selected. The mode is shown at the bottom of the display, and the measurement units appear at the right. Pressing a measurement key does this even if you are in a calibration sequence and also serves to cancel a change (ref. Leaving Calibration, pg. 14).

2. COND, RES and TDS Keys

These 3 keys are used with solution in the Conductivity Cell.

Precautions:

- While filling cell cup ensure no air bubbles cling on the cell wall.
- If the proper solution is not selected (KCl, NaCl, 442 or USER), refer to Why Solution Selection is Available, pg. 11 and Procedure to Select a Solution, pg. 11.

a. COND Key

Solution to be tested is introduced into the conductivity cell and a press

of  displays conductivity with units on the right. On the left is

shown the solution type selected for conductivity.

b. RES Key

A press of  displays resistivity with units on the right. On the left

is shown solution type selected for resistivity (ref. Solution Selection, pg. 11). The range of display of resistivity is limited to between 10 kilohms (KΩ) and 30 megohms (MΩ). A solution outside that range will only show [- - -] in the display.

c. TDS Key

A press of  displays Total Dissolved Solids with units on the right.

This is a display of the concentration of material calculated from compensated conductivity using the characteristics of a known material. On the left is shown solution type selected for TDS (ref. Solution Selection, pg. 11).

3. pH and ORP Keys

Measurements are made on solution held in the pH/ORP sensor well (ref. pH and ORP, pg. 43). The protective cap is removed and the sensor well is filled and rinsed with the sample enough times to completely replace the storage solution.

After use, the pH/ORP sensor well must be refilled with Myron L Storage Solution, and the protective cap reinstalled securely (ref. Maintenance of the pH/ORP Sensor, pg. 9 and Cleaning Sensors, 2. pH/ORP, pg. 32).

a. pH Key (6P)

A press of  displays pH readings. No units are displayed on the right.

b. ORP Key (6P)

A press of  displays Oxidation-Reduction Potential/REDOX

reading in millivolts, “mV” is displayed.

4. CAL/MCLR Key

A press of  allows you to enter the calibration mode while



measuring conductivity, TDS or pH. Once in CAL mode, a press of this key accepts the new value. If no more calibration options follow, the instrument returns to measuring (ref. Leaving Calibration, pg. 14).

If  is held down for about 3 seconds, CAL mode is not entered,

but “SEL” appears to allow Solution Selection (ref. pg. 11) with the Up or Down keys. As in calibration, the CAL key is now an “accept” key.

While reviewing stored records, the MCLR side of the key is active to allow clearing records (ref. Clearing a Record/Memory Clear, pg. 21).

5. UP or DOWN Keys

While measuring in any parameter, the  or  keys activate

the Memory Store and Memory Recall functions.

While in CAL mode, the keys step or scroll the displayed value up or down. A single press steps the display and holding either key scrolls the value rapidly.

While in Memory Recall, the keys scroll the display up and down through the stack of records (ref. Memory Recall, pg. 21).

IV. AFTER USING the Ultrameter II

A. Maintenance of the Conductivity Cell

Rinse out the cell cup with clean water. Do not scrub the cell. For oily films, squirt in a foaming non-abrasive cleaner and rinse (ref. Cleaning Sensors, pg. 32). Even if a very active chemical discolors the electrodes, this does not affect the accuracy; leave it alone.

B. Maintenance of the pH/ORP Sensor (6P)



The sensor well must be kept wet with a solution. Before replacing the rubber cap, rinse and fill the sensor well with Myron L pH Storage Solution. If unavailable, use an almost saturated KCl solution, pH 4 buffer or a saturated solution of table salt and tap water (ref. pH and ORP Practices, pg. 20). NEVER USE DISTILLED WATER.

V. SPECIFIC RECOMMENDED MEASURING PROCEDURES

If the proper solution is not selected (KCl, NaCl, 442 or USER), see Solution Selection, pg. 11.

NOTE: *After sampling high concentration solutions or temperature extremes, more rinsing may be required. When sampling low conductivity solutions, be sure the pH cap is well seated so that no solution washes into the conductivity cell from around the pH cap.*

A. Measuring Conductivity & Total Dissolved Solids (TDS)

1. Rinse cell cup 3 times with sample to be measured. (This conditions the temperature compensation network and prepares the cell.)
2. Refill cell cup with sample.
3. Press  or .

4. Take reading. A display of [- - -] indicates an overrange condition.

B. Measuring Resistivity

Resistivity is for low conductivity solutions. In a cell cup the value may drift from trace contaminants or absorption from atmospheric gasses, so measuring a flowing sample is recommended.

1. Ensure pH protective cap is secure to avoid contamination.
2. Hold instrument at 30° angle (cup sloping downward).
3. Let sample flow continuously into conductivity cell with no aeration.
4. Press  key; use best reading.

NOTE: If reading is lower than 10 kilohms display will be dashes: [- - - -]. Use Conductivity.

C. Measuring pH (6P)

1. Remove protective cap by squeezing its sides and pulling up.
2. Rinse sensor well 3 times with sample to be measured. Shake out each sample to remove any residual liquid.
3. Refill both sensor wells with sample.
4. Press .
5. Note value displayed.

6. **IMPORTANT:** After use, fill pH/ORP sensor well with Myron L pH Sensor Storage Solution and replace protective cap. If Myron L pH Sensor Storage Solution is unavailable, use a strong KCl solution, a pH 4 buffer, or a saturated solution of table salt and tap water (ref. Cleaning Sensors, 2. pH/ORP, pg. 32). *Do not allow pH/ORP sensor to dry out.*

D. Measuring ORP (6P)

1. Remove protective cap by squeezing its sides and pulling up.
2. Rinse sensor well 3 times with sample to be measured. Shake out each sample to remove any residual liquid.

3. Refill both sensor wells with sample.
4. Press .
5. Take reading.
6. **IMPORTANT:** After use, fill pH/ORP sensor well with Myron L pH Sensor Storage Solution and replace protective cap. If Myron L pH Sensor Storage Solution is unavailable, use a strong KCl solution, a pH 4 buffer, or a saturated solution of table salt and tap water (ref. Cleaning Sensors, 2. pH/ORP, pg. 32). *Do not allow pH/ORP sensor to dry out.*

VI. SOLUTION SELECTION

A. Why Solution Selection is Available

Conductivity, resistivity, and TDS require temperature correction to 25°C values (ref. Standardized to 25°C, pg. 38). Selection determines the temperature correction of conductivity and calculation of TDS from compensated conductivity (ref. Cond. Conversion to TDS, pg. 40).

B. The 4 Solution Types

On the left side of the display is the salt solution characteristic used to model temperature compensation of conductivity and its TDS conversion. Generally, using KCl for conductivity, NaCl for resistivity, and 442 (Natural Water characteristic) for TDS will reflect present industry practice for standardization. This is how your instrument is shipped from the factory (ref. Solution Characteristics, pg. 40).

The USER selection allows a custom value to be entered for the temperature compensation of conductivity and also the conversion ratio if measuring TDS.

C. Calibration of Each Solution Type

There is a separate calibration for each of the 4 solution types. Note that calibration of a 442 solution does not affect the calibration of a NaCl solution. For example: Calibration (ref. Conductivity or TDS Calibration, pg. 15) is performed separately for each type of solution one wishes to measure (ref. Conductivity/TDS Standard Solutions, pg. 36).

D. Procedure to Select a Solution

NOTE: Check display to see if solution displayed (KCl, NaCl, 442 or USER) is already the type desired. If not:

1. Press ,  or  to select the parameter on which

you wish to change the solution type.

2. Press and hold $\left(\frac{\text{CAL}}{\text{MCLR}}\right)$ key

for 3 seconds to make "SEL" appear (see Figure 1). For demonstration purposes, all 4 solution types are shown simultaneously.



Figure 1

3. Use the $\left(\frac{\blacktriangle}{\text{MS}}\right)$ or $\left(\frac{\text{MR}}{\blacktriangledown}\right)$ key to select type of solution desired

(ref. Solution Characteristics, pg. 40). The selected solution type will be displayed: KCl, NaCl, 442 or User.

4. Press $\left(\frac{\text{CAL}}{\text{MCLR}}\right)$ to accept new solution type.

E. Application of USER Solution Type

1. User Programmable Temperature Compensation (Tempco)

This feature allows you to change your Ultrameter II's temperature compensating factor to another factor between 0-9.99%/°C (ref. Temperature Compensation, pg. 37). This feature does not apply to pH or ORP.

- a. As in Procedure to Select a Solution, pg. 11, select "USER" mode.
- b. With "USER" mode now selected, press $\left(\frac{\text{CAL}}{\text{MCLR}}\right)$. You may now adjust a temperature compensation from .00%/°C to 9.99%/°C, by pressing $\left(\frac{\blacktriangle}{\text{MS}}\right)$ or $\left(\frac{\text{MR}}{\blacktriangledown}\right)$.

See example in Figure 2.

- c. Press $\left(\frac{\text{CAL}}{\text{MCLR}}\right)$ twice to skip calibration adjustment and accept the new tempco (3 times if in TDS mode). You are now ready to measure samples with your new temperature compensation factor.

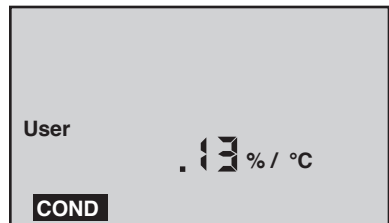

Figure 2

2. Disabling Temperature Compensation

- Select USER mode, see Procedure to Select a Solution, pg. 11.
- With "USER" selected, press $\frac{\text{CAL}}{\text{MCLR}}$. If the display does not show .00%/°C, hold $\frac{\text{MR}}{\text{▼}}$ long enough to bring the tempco to .00%/°C (see Figure 3).
- Press $\frac{\text{CAL}}{\text{MCLR}}$ twice (3 times if in TDS mode). Temperature compensation is now disabled (=0) for measurements in USER mode.

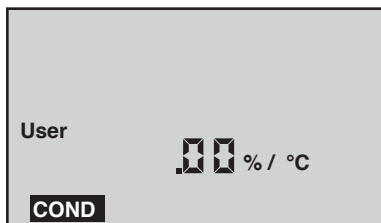

Figure 3

3. User Programmable Conductivity to TDS Ratio

This feature allows you to select a custom conductivity to TDS conversion ratio within the range of 0.20-7.99 for USER mode measurements. To determine the conversion ratio for a custom solution of **known** TDS ppm value, measure the solution conductivity **at 25°C** with the Ultrameter II and divide the ppm value by the μS value. For example, a solution of known 75ppm TDS and measured $100\mu\text{S}$ conductivity at 25°C would have a conversion ratio of 75/100 or 0.75. Enter the new conversion ratio as follows:

- While in "USER" mode, press $\frac{\text{TDS}}{\text{○}}$.
- Press $\frac{\text{CAL}}{\text{MCLR}}$ twice (to skip over tempco adjustment) and "RATIO" will appear (see Figure 4).
- Adjust with $\frac{\text{▲}}{\text{MS}}$ or $\frac{\text{MR}}{\text{▼}}$ key until new conversion ratio is displayed.
- Press $\frac{\text{CAL}}{\text{MCLR}}$ twice (to skip over calibration adjustment) to

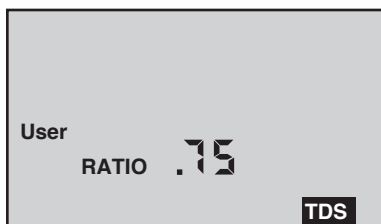

Figure 4

accept new conversion ratio. You are now ready to measure samples with the new conductivity/TDS ratio.

In these first six sections, you have learned all you need to make accurate measurements. The following sections contain calibration, advanced operations and technical information.

VII. CALIBRATION

A. Calibration Intervals



Generally, calibration is recommended about once per month with Conductivity or TDS solutions. Calibration with pH solutions should be checked twice a month. Calibration of ORP is not necessary (ref. CALIBRATION INTERVALS, pg. 19).

B. Rules for Calibration of the Ultrameter II

1. Calibration Steps



a. Starting Calibration

Calibration is begun by pressing  while measuring Conductivity, TDS or pH. Measuring continues, but the CAL icon is on, indicating calibration is now changeable.

The reading is changed with the  and  keys to match the known value. The calibration for each of the 4 solution types may be performed in either conductivity or TDS mode.

Depending on what is being calibrated, there may be 1, 2 or 3 steps to the calibration procedures.

	KCl, NaCl or 442	User
Cond	Gain only	Tempco, then Gain
Res	Done in conductivity	Done in conductivity or TDS
TDS	Gain only	Tempco, Ratio, then Gain
pH	7, acid and/or base (6P)	
ORP	Zero set with pH 7 automatically (6P)	

Once in "CAL" mode, the  key becomes an "ACCEPT" key. At each point, pressing  accepts the new calibration value and steps you to the next adjustment (or out of CAL mode if there are no more steps).

To bypass a calibration step, simply press  to accept the present value as is.

b. Leaving Calibration

Calibration is complete when the "CAL" icon goes out. Pressing any

measurement key cancels changes not yet accepted and exits calibration mode.

Leaving pH after the 2nd buffer results in the same gain being entered in place of the 3rd buffer.

2. Calibration Limits

There are calibration limits. A nominal “FAC” value is an ideal value stored by the factory. Attempts to calibrate too far, up or down, from there will cause the displayed value to be replaced with “FAC”. If you accept it (press the “Cal” key), you will have the original default factory calibration for this measurement. The need to calibrate so far out that “FAC” appears indicates a procedural problem, incorrect standard solution, a very dirty cell cup or an aging pH/ORP sensor (ref. Troubleshooting Chart, pg. 34).

C. Calibration Procedures

1. Conductivity or TDS Calibration

a. Rinse conductivity cell three times with proper standard (KCl, NaCl, or 442) (ref. Cond/TDS Standard Solutions, pg. 36). For user calibration see User Calibration Conductivity/TDS below.

b. Refill conductivity cell with same standard. KCl-7000 shown.

c. Press  or , then

press , “CAL” icon will

appear on the display (see Figure 5).



Figure 5

d. Press  or  to







step the displayed value toward the standard’s value (7032 > 7000) or hold a key down to scroll rapidly through the reading.

e. Press  once to confirm new value and end the

calibration sequence for this particular solution type. If another solution type is also to be measured, change solution type now and repeat this procedure.

2. User Calibration Conductivity/TDS

Instrument must be in **USER** mode, see Solution Selection, pg. 11.





- a. Rinse conductivity cell three times with your standard.
- b. Refill conductivity cell with same standard.
- c. Press  or , then press  twice in COND/three times in TDS. The “**CAL**” icon will appear on the display.
- d. Press  or  to step the displayed value toward the standard's value or hold a key down to scroll rapidly through the reading.
- e. Press  once to confirm new value and end the calibration sequence for this particular solution type.

3. Resistivity Calibration

Resistivity is the reciprocal of Conductivity. Resistivity is calibrated only if conductivity is calibrated for the same solution type.

4. Reloading Factory Calibration (Cond or TDS)

If calibration is suspect or known to be incorrect, and no standard solution is available, the calibration value can be replaced with the original factory value for that solution. This “FAC” value is the same for all Ultrameter IIs, and returns you to a known state without solution in the cell. The “FAC” internal electronics calibration (which bypasses the electrodes and cell) is not intended to replace calibration with conductivity standard solutions. If another solution type requires resetting, change solution type and repeat this procedure.

- a. Press  or .
- b. Press . (If in USER solution mode, press CAL key twice if in Conductivity, and three times if in TDS to skip over tempco and ratio adjustments.)
- c. Press  key until “**FAC**” appears and release.
- d. Press  to accept the factory calibration setting.

5. pH Calibration (6P)

Important: Always “zero” your Ultrameter II with a pH 7 buffer solution before adjusting the gain with acid or base buffers, i.e., 4 and/or 10, etc.

a. pH Zero Calibration (6P)

1. Rinse sensor well 3 times with 7 buffer solution.

2. Refill both sensor wells with 7 buffer solution.

3. Press  to verify the pH calibration. If the display shows 7.00, skip the pH Zero Calibration and proceed to section b. pH Gain Calibration.

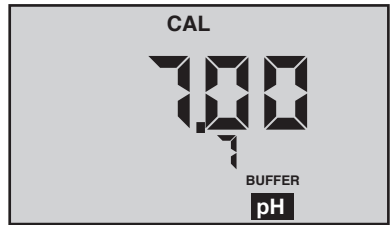



Figure 6

4. Press  to enter calibration mode. The “CAL”, “BUFFER” and “7” annunciators will appear (see Figure 6). Displayed value will be the uncalibrated sensor.



NOTES: If a wrong buffer is added (outside of 6-8 pH), “7” and “BUFFER” will flash, and the Ultrameter II will not adjust.

The uncalibrated pH value displayed in step 4 will assist in determining the accuracy of the pH sensor. If the pH reading is above 8 with pH 7 buffer solution, the sensor well needs additional rinsing or the pH sensor is defective and needs to be replaced.

5. Press  or  until the display reads 7.00.

NOTE: Attempted calibration of >1 pH point from factory calibration will cause “FAC” to appear. This indicates the need for sensor replacement (ref. Troubleshooting pg. 34) or fresh buffer solution. The “FAC” internal electronic calibration is not intended to replace calibration with pH buffers. It assumes an ideal pH sensor. Each “FAC” indicates a factory setting for that calibration step (i.e., 7, acid, base).

You may press  to accept the preset factory value, or you may

reduce your variation from factory setting by pressing  or .

6. Press  to accept the new value. The pH Zero Calibration is now complete. You may continue with pH Gain Calibration or exit by pressing any measurement key.

b. pH Gain Calibration (6P)

Important: Always calibrate or verify your Ultrameter II with a pH 7 buffer solution before adjusting the gain with acid or base buffers, i.e., 4 and/or 10, etc. Either acid or base solution can be used for the 2nd point “Gain” calibration and then the opposite for the 3rd point. The display will verify that a buffer is in the sensor well by displaying either “Acd” or “bAS”.

1. The pH calibration mode is initiated by either completion of the pH Zero Calibration, or verifying 7 buffer and pressing the



key twice while in pH measurement mode.

2. At this point the “CAL”, “BUFFER” and “Acd” or “bAS” annunciators will be displayed (see Figures 7 and 8).

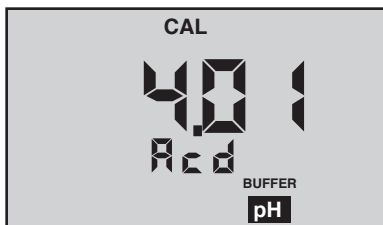

Figure 7

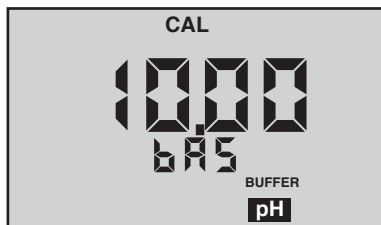





Figure 8

NOTE: If the “Acd” and “bAS” indicators are blinking, the unit is indicating an error and needs either an acid or base solution present in the sensor well.

3. Rinse sensor well 3 times with acid or base buffer solution.
4. Refill sensor well again with same buffer solution.
5. Press  or  until display agrees with buffer value.

6. Press  to accept 2nd point of calibration. Now the display indicates the next type of buffer to be used.

Single point Gain Calibration is complete. You may continue for the 3rd point of Calibration (2nd Gain) or exit by pressing any measurement key. Exiting causes the value accepted for the buffer to be used for both acid and base measurements.

To continue with 3rd point calibration, use basic buffer if acidic buffer was used in the 2nd point, or vice-versa. Again, match the display to the known buffer value as in step 2 and continue with the following steps:

7. Repeat steps 3 through 6 using opposite buffer solution.

8. Press  to accept 3rd point of calibration, which completes the Calibration procedure. Fill sensor well with Myron L Storage Solution and replace protective cap.

6. ORP Calibration (6P)

ORP electrodes rarely give false readings without problems in the reference electrode. For this reason, and because calibration solutions for ORP are highly reactive and potentially hazardous, your Ultrameter II has an electronic ORP calibration. This causes the zero point on the reference electrode to be set whenever pH 7 calibration is done.

7. Temperature Calibration

Temperature calibration is not necessary in the Ultrameter II.

VIII. CALIBRATION INTERVALS

There is no simple answer as to how often one should calibrate an instrument. The Ultrameter II is designed to not require frequent recalibration. The most common sources of error were eliminated in the design, and there are no mechanical adjustments. Still, to ensure specified accuracy, any instrument must be checked against chemical standards occasionally.

A. Suggested Intervals

On the average, we expect calibration need only be checked monthly for the Conductivity, RES or TDS functions. The pH (6P) function should be checked every 2 weeks to ensure accuracy. Measuring some solutions will require more frequent intervals.

B. Calibration Tracking Records

To minimize your calibration effort, keep records. If adjustments you are making are minimal for your application, you can check less often. Changes in conductivity calibration should be recorded in percent. Changes in pH calibration (6P) are best recorded in pH units.

Calibration is purposely limited in the Ultrameter II to $\pm 10\%$ for the conductivity cell, as any change beyond that indicates damage, not drift. Likewise, calibration changes are limited to ± 1 pH unit (6P), as any change beyond that indicates the end of the sensor's lifetime and replacement is recommended.

C. Conductivity, RES, TDS Practices to Maintain Calibration

1. Clean oily films or organic material from the cell electrodes with foaming cleaner or mild acid. Do not scrub inside the cell.
2. Calibrate with solutions close to the measurements you make. Readings are compensated for temperature based on the type of solution. If you choose to measure tap water with a KCl compensation, which is often done (ref. An Example, pg. 38), and you calibrate with 442 solution because it is handy, the further away from 25°C you are, the more error you have. Your records of calibration changes will reflect temperature changes more than the instrument's accuracy.
3. Rinse out the cell with pure water after taking measurements. Allowing slow dissolving crystals to form in the cell contaminates future samples.
4. For maximum accuracy, keep the pH sensor cap on tight so that no fluid washes into the conductivity cell.

D. pH and ORP Practices to Maintain Calibration (6P)

1. Keep the sensor wet with Myron L Storage Solution.
2. Rinse away caustic solutions immediately after use.

ORP calibration solutions are caustic, and $\pm 5\%$ is considered very accurate. By using the pH zero setting (0 mV = 7 pH) for ORP and precision electronics for detection, the Ultrameter II delivers better accuracy without calibration than a simpler instrument could using calibration solutions.

IX. MEMORY

This feature allows up to 100 readings with their temperatures to be stored simultaneously for later recall. At the same time, the TIME and DATE are also recorded. To download the memory to a computer, (ref. uDock™ IR Data Port, pg. 30).

1. A. Memory Storage
While displaying a measurement, press



to record the displayed value.

2. “MEMORY” will appear and the temperature display will be momentarily replaced by a number (1-100) showing the position of the record. Figure 9 shows a reading of 1806 μS stored in memory record #4.

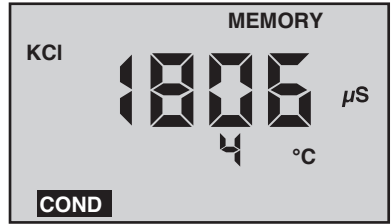







Figure 9

B. Memory Recall







1. Press any measurement key.
2. Press , “MEMORY” will appear, and the display will show the last record stored.
3. Press  or  to scroll to the record location desired (the temperature display alternates between temperature recorded and location number).
4. Press  to display time and date stamp.
5. Press any measurement key to leave memory recall or allow to automatically turn off.

C. Clearing a Record/Memory Clear

After recalling a certain record location, press and HOLD  to

clear that memory. This space will be the place for the next memory record, unless you scroll to another empty position before ending the recall sequence. The next memory stored will go into the next highest available memory location.

Example: You have locations 1-7 filled and wish to clear the conductivity reading stored in record location #3 and replace it with a pH reading.

1. Press  and scroll to location #3.
2. Press and HOLD  to clear old record #3.
3. Fill pH/ORP sensor well with sample.
4. Press  to measure sample and press  to store reading in location #3.
5. The next memory stored will go into location #8.
6. To clear **all** records: After pressing , scroll down. "CLF ALL" will be displayed (see Figure 10).
7. Press . All records will be cleared.

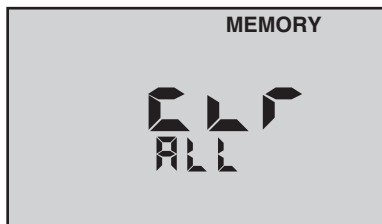

Figure 10

X. TIME and DATE

The Time and Date may easily be changed as you travel.

A. Setting TIME

Time is always displayed in 24 hour time.

Example shown in Figure 11, 16:05 equals 4:05 PM.



1. Press .
2. Press  until the time is displayed (stored readings, PC OFF, CLF ALL, time i.e. "16:05").
3. Press  to initiate. **CAL** will be displayed along with the time, (see Figure 11).



Figure 11

4. Press the $\left(\frac{\blacktriangle}{\text{MS}}\right)$ or $\left(\frac{\text{MR}}{\blacktriangledown}\right)$ to change the time.
5. Press $\left(\frac{\text{CAL}}{\text{MCLR}}\right)$ to accept the change (new time).

B. Setting DATE

Example shown in Figure 12, is in US format i.e. mo/dy/yr.
 NOTE: The default format is US.
 Date format may be changed (ref. Date Format "US and International (Int)", pg. 24).

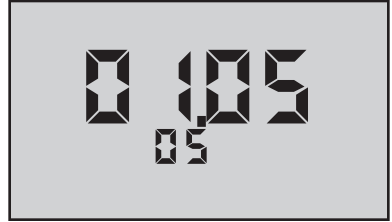

Figure 12

1. Press $\left(\frac{\text{COND}}{\text{MCLR}}\right)$.
2. Press $\left(\frac{\text{MR}}{\blacktriangledown}\right)$ repeatedly until the date is displayed (stored readings, PC OFF, CLF ALL, time, date, i.e. **01.05/05** (January 5, 2005)).
3. Press $\left(\frac{\text{CAL}}{\text{MCLR}}\right)$ to initiate. **CAL** will be displayed along with the YEAR, (see Figure 13).



Figure 13

4. Press $\left(\frac{\blacktriangle}{\text{MS}}\right)$ or $\left(\frac{\text{MR}}{\blacktriangledown}\right)$ to change the YEAR.
5. Press $\left(\frac{\text{CAL}}{\text{MCLR}}\right)$ to accept the change (new year).
6. Press $\left(\frac{\blacktriangle}{\text{MS}}\right)$ or $\left(\frac{\text{MR}}{\blacktriangledown}\right)$ to change the month.
7. Press $\left(\frac{\text{CAL}}{\text{MCLR}}\right)$ to accept the change (new month), (see Figure 14).

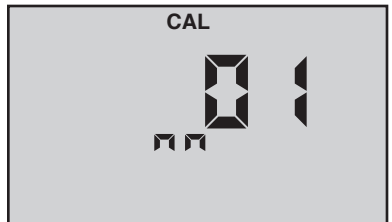



Figure 14

8. Press the  or  to change the day.

9. Press  to accept the change (new day) (see Figure 15).

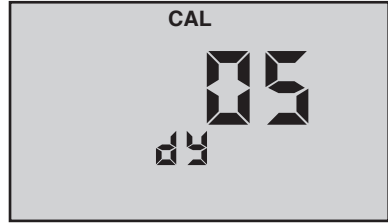



Figure 15

C. DATE FORMAT “US & International (Int)”

1. Press .

2. Press  repeatedly until the format is displayed (stored readings, PC OFF, CLF ALL, time, date, date **format**).

3. Press  to change. Display will now indicate other format (see Figures 16 & 17).

4. Press any measurement key or allow to automatically turn off.

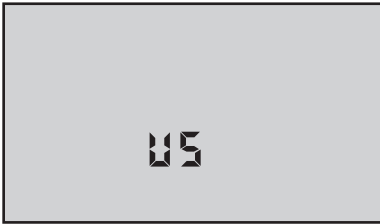

Figure 16

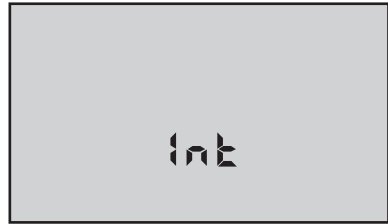



Figure 17

XI. TEMPERATURE FORMAT “Centigrade & Fahrenheit”

1. Press .

2. Press  to display the stored memory records.

3. Press  repeatedly until you pass the “US” or “Int” date

format location. The display will show a “C” or “F” (see Figures 18 and 19).

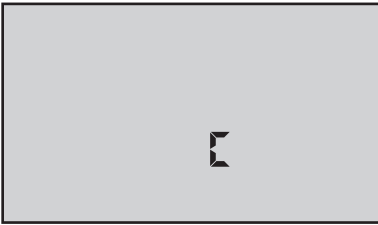



Figure 18



Figure 19

4. Press  to switch units.
5. Press  to accept unit preference for all temperature readings.

NOTE: *Tempco will still be shown in %/°C.*

XII. TOTAL RETURN to FACTORY SETTINGS “FAC SEL”

There may come a time when it would be desirable to quickly reset all the recorded calibration values in the instrument back to the factory settings. This might be to ensure all calibrations are set to a known value, or to give the instrument to someone else free of adjustments or recorded data for a particular application.

NOTE: All stored data will be lost.









1. Press .
2. Press  to display the stored memory records.
3. Press  repeatedly until you pass the CLR ALL and the C-F locations. The display will show a “**FAC SEL**” (see Figure 20).
4. Press  to accept the resetting. Display will return to Cond.



Figure 20

XIII. CELL CHECK

The cell check verifies the cleanliness of the conductivity/TDS/resistivity sensor. In normal use the cell may become dirty or coated and require cleaning. If the display is showing “.00” when the cell cup is dry, the sensor is probably clean. However, when testing high purity water in resistivity (RES) mode improved accuracy may be desired. No matter what a manufacturer claims, a sensor can and will become contaminated or coated; therefore require cleaning. A true 4-wire sensor, as in the Ultrameter II, helps to mitigate contamination, but NO SENSOR IS 100% IMMUNE.

1. Press .
2. Press  to display the stored memory records.
3. Press  repeatedly until you pass the **FAC SEL** location. The display will show a “**CELL ch**” (see Figure 21).
4. Press  to test.

If cell is clean, **Good** will momentarily be displayed (see Figure 22). If cell is dirty, **CELL cLn** will be displayed (see Figure 23), (ref. Cleaning Sensors, pg. 32).

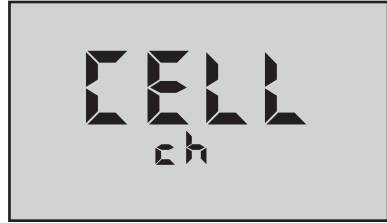

Figure 21

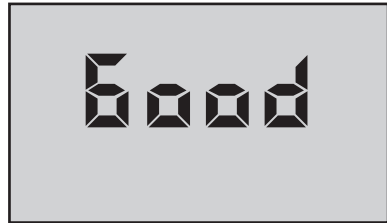

Figure 22



Figure 23

XIV. AUTO OFF

Auto off allows the user to adjust the time the instrument is ON (up to 75 seconds) after each press of a key. Default time is 15 seconds with 60 seconds in CAL (calibration) mode.

1. Press .

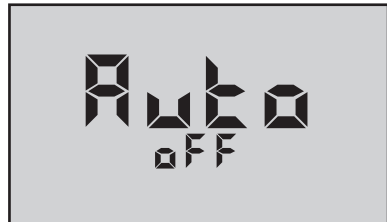





Figure 24

2. Press  to display the stored memory records.
3. Press  repeatedly until you pass the CELL ch location.
The display will show “Auto OFF” (see Figure 24).

4. Press  to initiate. **CAL** will be displayed along with the “**15 SEC**” (see Figure 25).

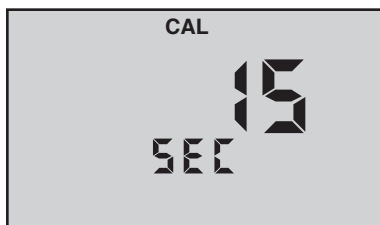



Figure 25

5. Press  or  to change the time (see Figure 26). Maximum time is shown.

6. Press  to accept the change (new time).

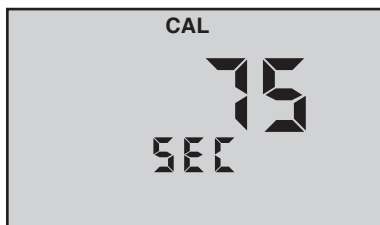



Figure 26

XV. USER MODE CALIBRATION LINC™ FUNCTION

Linc™ function allows easy calibration when in User mode and the user does not have a user standard solution to calibrate the instrument. This function will ensure more repeatable and accurate measurements than many other calibration methods. It is recommended that this function be used to provide the highest degree of confidence when the Ultrameter II is used in “User” mode. When Linc is used, the User mode is linked to another standard, i.e. if User and KCI are linked, a KCI standard solution is used to calibrate the instrument. It is that simple.

A. Calibration of Ultrameter II for use in User Mode



1. Press  or  key.
2. Calibrate the unit using a Standard Solution, (ref. CALIBRATION, pg. 14).
3. Place the Ultrameter II in User mode, (ref. SOLUTION SELECTION, pg. 11).

- Verify/Set the calibration linc. (See below – Setting User Mode Calibration Linc).

B. Setting User Mode Calibration “Linc”

The linc function sets or “links” the calibration gain factor of a Standard Solution to the User solution mode. Once set, the “linc” will stay intact with future calibrations unless the linc has been canceled. For more information on canceling the User Mode Calibration Linc refer to the section “Canceling User Mode Calibration Linc”, pg. 29.

Follow the steps below to set either the KCl, NaCl or 442 calibration factor to the User solution mode.

- Press measurement key desired to be “Linked”, i.e. ,  or .

- Place the Ultrameter II in User mode, (ref. SOLUTION SELECTION, pg. 11, for selecting the User Mode).

- Press  arrow key until the menu “Linc” appears (see Figure 27).

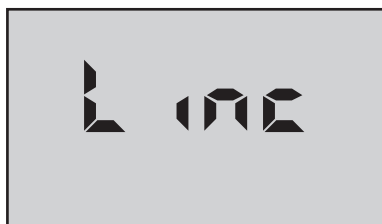

Figure 27

- Press  key. The instrument will display “SEL” and the “User” Icon (see Figure 28).



Figure 28

Any additional display of KCl, NaCl or 442 icons indicates a linc between the User solution and the other solution displayed.



- Press  or  keys to select a Standard Solution to be linked to the User mode calibration constant, (see Figure 29). **User** linked to **KCl**.





Figure 29

If none of the Solution Selection icons are displayed, (i.e. KCl, NaCl or 442) nothing has been linked to User mode.





6. Press  key to accept the setting. Pressing any of the measurement keys will exit without changing the setting. User mode “linc” is now complete. The User mode will now use the calibration gain constant used for the calibration of the Standard Solution as outlined above.

C. Canceling User Mode Calibration “Linc”

The Ultrameter II must be in **User** linked mode in order to cancel the “linc”, (ref. SOLUTION SELECTION, pg. 11).

1. Press “Linked” measurement key ,  or .

Two solution icons will be shown in the left side of display - “**User**” and another, i.e., “**KCI**”.

2. Press  key until the menu “**Linc**” appears, (see Figure 27).
3. Press  key, the instrument will display both “**SEL**” and the “**User**” Icon.
4. Press  key until “**User**” is the only solution icon being displayed.
5. Press  key.
6. The User mode calibration “Linc” has now been canceled.

NOTES:

1. To maintain repeatability, use the same standard solutions for future calibrations.
2. Calibration of the Ultrameter II Gain Factor for User mode is not available when the calibration linc has been established. The other calibration functions (i.e. Temperature Compensation %/C settings and TDS Ratio settings) are still intact. To perform a calibration of the User mode as described in User Calibration Conductivity/TDS, pg. 15, the User Mode Linc should be canceled. See above Canceling User Mode calibration “Linc”.
3. Once a “linc” has been established for User mode, the “linc” will apply

to all measurement modes using User solution selection (i.e. TDS/User, Cond/User or Res/User).

XVI. uDock™ IR DATA PORT INSTRUCTIONS

Requires Myron L uDock™ accessory package, Model # U2CIP. The Myron L uDock is powered via the USB port, requiring no external power source. The uDock application will operate on Windows 2000 & XP*, and Macintosh OS9.2 & OSX** based computer systems.

A. Software Installation



1. Place Myron L Ultrameter II uDock Installation CD into your computer.
2. Upon opening, select the folder for your operating system.
3. Install uDock application. See detailed installation instructions on CD.
4. Additional drivers may be required. See our website for the latest information.

B. Hardware Setup

1. Connect USB cable (provided with uDock) to your computer. Assuming your computer is on, the uDock GREEN LED will illuminate indicating there is power to the uDock and that a proper connection has been made.

C. Memory Stack Download

1. Launch the application using the uDock icon.
2. Select the proper comm port setting (first time only).
3. Place CLEAN, DRY Ultrameter II on uDock.

4. Press  key.
5. Press and HOLD  key until the menu "PC OFF" appears, (see Figure 30).

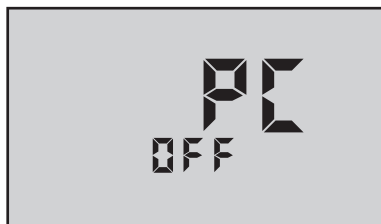

Figure 30

6. Press  key. “PC On”

will be displayed, (see Figure 31). The GREEN LED on the uDock will now be blinking periodically, indicating communication has been established between the Ultrameter II and the uDock.

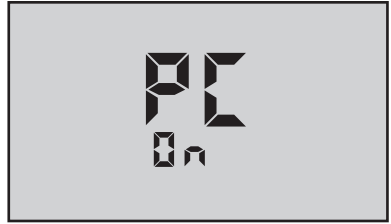

Figure 31

NOTE. “PC Ini” may momentarily be displayed while initializing, (see Figure 32).

7. On your computer, click on the data download button. A data transfer bar will appear while the data is being downloaded.

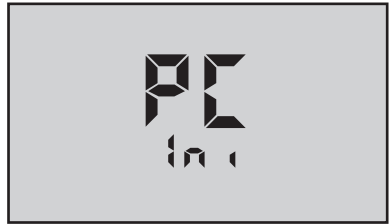

Figure 32

Once downloaded, the data may be manipulated, printed or stored within the Myron L uDock application, or the data may be exported to another more powerful spreadsheet † such as Excel*.

† Please Note: Although the Myron L Company has performed extensive testing, we can not guarantee compatibility of all applications and formats. We suggest testing your application and format for compatibility before relying on it.

Additional features such as setting time and date and erasing data are available. See uDock software installation CD or visit www.myronl.com for the latest instructions.

8. Upon completion, click on the “disconnect” icon.
9. Turn off Ultrameter II PC download mode by selecting any measurement function. Failure to do so will reduce battery life.

XVII. CARE and MAINTENANCE

Ultrameter IIs should be rinsed with clean water after use. Solvents should be avoided. Shock damage from a fall may cause instrument failure.

A. Temperature Extremes

Solutions in excess of 71°C/160°F should not be placed in the cell cup area; this may cause damage. The pH sensor may fracture if the Ultrameter II temperature is allowed to go below 0°C/32°F. Care should be exercised not to exceed rated operating temperature.

Leaving the Ultrameter II in a vehicle or storage shed on a hot day can easily subject the instrument to over 66°C/150°F. This will void the warranty.

B. Battery Replacement

Dry Instrument THOROUGHLY. Remove the four (4) bottom screws. Open instrument carefully. Carefully detach battery from circuit board. Replace with 9 volt alkaline battery. Replace bottom, ensuring the sealing gasket is installed in the groove of the top half of case. Re-install screws, tighten evenly and securely.

NOTE: Because of nonvolatile EEPROM circuitry, all data stored in memory and all calibration settings are protected even during power loss or battery replacement. However, loss of time and date may occur if battery is removed for longer than 3 minutes (180 seconds).

C. pH/ORP Sensor Replacement (6P)

Order model RPR. When ordering, be sure to include the model and serial number of your instrument to ensure receipt of the proper type. Complete installation instructions are provided with each replacement sensor.

D. Cleaning Sensors

1. Conductivity/TDS/Resistivity

The conductivity cell cup should be kept as clean as possible. Flushing with clean water following use will prevent buildup on electrodes. However, if very dirty samples — particularly scaling types — are allowed to dry in the cell cup, a film will form. This film reduces accuracy. When there are visible films of oil, dirt, or scale in the cell cup or on the electrodes, use isopropyl alcohol or a foaming non-abrasive household cleaner. Rinse out the cleaner and your Ultrameter II is again ready for accurate measurements.

2. pH/ORP (6P)

The unique pH/ORP sensor in your Ultrameter II is a nonrefillable combination type that features a porous liquid junction. *It should not be*

allowed to dry out. However, if this occurs, the sensor may sometimes be rejuvenated by first cleaning the sensor well with Isopropyl alcohol or a liquid spray cleaner such as Windex™ or Fantastic™ and rinsing well. Do not scrub or wipe the pH/ORP sensor.

Then use one of the following methods:

1. Pour a HOT salt solution ~60°C/140°F, preferably potassium chloride (KCl) solution (Myron L pH/ORP Sensor Storage Solution) — HOT tap water with table salt (NaCl) will work fine — in the sensor well and allow to cool. Retest.
or
2. Pour DI water in the sensor well and allow to stand for no more than 4 hours (longer can deplete the reference solution and damage the glass bulb). Retest.

If neither method is successful, the sensor must be replaced.

“Drifting” can be caused by a film on the pH sensor bulb and/or reference. Use isopropyl alcohol (IPA) or spray a liquid cleaner such as Windex™ or Fantastic™ into the sensor well to clean it. The sensor bulb is very thin and delicate. Do not scrub or wipe the pH/ORP sensor.

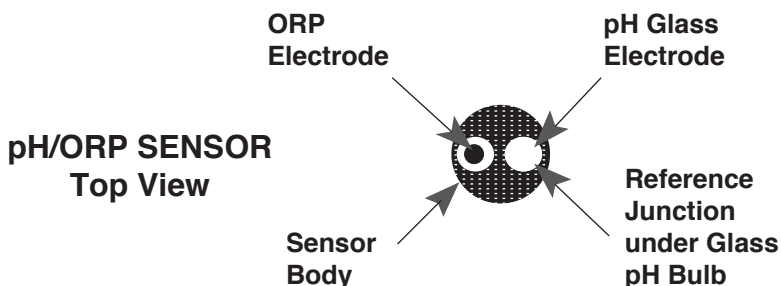

Leaving high pH (alkaline) solutions in contact with the pH sensor for long periods of time is harmful and will cause damage. Rinsing such liquids from the pH/ORP sensor well and refilling it with Myron L Storage Solution, a saturated KCl solution, pH 4 buffer, or a saturated solution of table salt and tap water, will extend the useful life.

Samples containing chlorine, sulfur, or ammonia can “poison” any pH electrode. If it is necessary to measure the pH of any such sample, thoroughly rinse the sensor well with clean water immediately after taking the measurement. Any sample element that reduces (adds an electron to) silver, such as cyanide, will attack the reference electrode.

Replacement sensors are available only from the Myron L Company or its authorized distributors.

XVIII. TROUBLESHOOTING CHART

Symptom	Possible Cause
No display , even though measurement key pressed	Battery weak or not connected.
Inaccurate pH readings (6P)	<ol style="list-style-type: none"> 1. pH calibration needed. Ref. pH Cal., pg. 17. 2. Cross-contamination from residual pH buffers or samples in sensor well. 3. Calibration with expired pH buffers.
No response to pH changes (6P)	Sensor bulb is cracked or an electromechanical short caused by an internal crack.
Will not adjust down to pH 7 (6P)	pH/ORP sensor has lost KCl.
<p>pH readings drift or respond slowly to changes in buffers/samples</p> <p><i>or</i></p> <p>“FAC” is displayed repeatedly (6P)</p>	<ol style="list-style-type: none"> 1. Temporary condition due to “memory” of solution in pH sensor well for long periods. 2. Bulb dirty or dried out. 3. Reference junction clogged or coated.
Unstable Conductivity/TDS/Resistivity readings	<ol style="list-style-type: none"> 1. Dirty electrodes. 2. Test samples greater than 1 megohm.
Unable to calibrate Conductivity/TDS	Film or deposits on electrodes.
Resistivity readings much lower than expected	<ol style="list-style-type: none"> 1. Contamination from previous sample or from pH sensor well. 2. Carbon dioxide in test sample.

Corrective Action
Check connections or replace battery. Ref. Battery Replacement, pg. 32.
1. Recalibrate instrument. 2. Thoroughly rinse sensor well. 3. Recalibrate using fresh buffers. Ref. pH Buffer Solutions, pg. 36.
Replace pH/ORP sensor. Ref. Replacement pH/ORP Sensor, pg. 37.
Clean and rejuvenate sensor (ref. Cleaning Sensors, pg. 32) and recalibrate. If no improvement, replace pH/ORP sensor (ref. Replacement pH/ORP Sensor, pg. 37).
Clean and rejuvenate sensor (ref. Cleaning Sensors, pg. 32) and recalibrate. If no improvement, replace pH/ORP sensor (ref. Replacement pH/ORP Sensor, pg. 37).
1. Clean cell cup and electrodes. Ref. Cleaning Sensors, pg. 32. 2. Minimize test sample exposure to air. Ref. Measuring Resistivity, pg. 10.
Clean cell cup and electrodes. Ref. Cleaning Sensors, pg. 32.
1. Rinse cell cup more thoroughly before measurement. Ensure pH cap is snugly in place. 2. See Measuring Resistivity, pg. 10.

XIX. ACCESSORIES

A. Conductivity/TDS Standard Solutions

Your Ultrameter II has been factory calibrated with the appropriate Myron L Company NIST traceable KCl, NaCl, and our own 442™ standard solutions. Most Myron L conductivity standard solution bottles show three values referenced at 25°C: Conductivity in microsiemens/micromhos, the ppm/TDS equivalents (based on our 442 Natural Water™) and NaCl standards. All standards are within ±1.0% of reference solutions. *Available in 2 oz., quarts/liters, and gallon/~3.8 liter bottles.*

1. Potassium Chloride (KCl)

The concentrations of these reference solutions are calculated from data in the International Critical Tables, Vol. 6. The 7000 μ S is the recommended standard. *Order KCL-7000*

2. 442 Natural Water™

442 Natural Water Standard Solutions are based on the following salt proportions: 40% sodium sulfate, 40% sodium bicarbonate, and 20% sodium chloride, which represent the three predominant components (anions) in freshwater. This salt ratio has conductivity characteristics approximating fresh natural waters and was developed by the Myron L Company over four decades ago. It is used around the world for measuring both conductivity and TDS in drinking water, ground water, lakes, streams, etc. 3000 ppm is the recommended standard. *Order 442-3000*

3. Sodium Chloride (NaCl)

This is especially useful in sea water mix applications, as sodium chloride is the major salt component. Most Myron L standard solution labels show the ppm NaCl equivalent to the conductivity and to ppm 442 values. The 14.0 mS is the recommended standard. *Order NACL-14.0*

B. pH Buffer Solutions (6P)

pH buffers are available in pH values of 4, 7 and 10. Myron L Company buffer solutions are traceable to NIST certified pH references and are color-coded for instant identification. They are also mold inhibited and accurate to within ±0.01 pH units @ 25°C. Order 4, 7 or 10 Buffer. *Available in 2 oz., quarts/liters, and gallon/~3.8 liter bottles.*

C. pH Sensor Storage Solution (6P)

Myron L pH Sensor Storage Solution prolongs the life of the pH sensor. *Available in 2 oz., quarts/liters, and gallon/~3.8 liter bottles.*

D. Soft Protective Carry Cases

Padded Nylon carrying case features a belt clip for hands-free mobility. Two colors to choose from;

Blue - Model #: UCC

Desert Tan - Model #: UCCDT

E. Hard Protective Carry Cases

Large case with 2 oz. bottles of calibration standard solutions (KCl-7000, 442-3000, 4, 7, & 10 pH buffers and pH storage solution).

Model #: PKUU

Small case (no calibration standard solutions) - *Model #: UPP*

F. Replacement pH/ORP Sensor (6P)

pH/ORP sensor is gel filled and features a unique porous liquid junction. It is user-replaceable and comes with easy to follow instructions.

Model #: RPR

G. uDock™ IR Data Port Accessory Package

This accessory allows the operator to download the Ultrameter II memory stack to a spreadsheet on a computer. The package includes a uDock, software CD, and installation and operating instructions.

Model #: U2CIP

XX. TEMPERATURE COMPENSATION (Tempco) of Aqueous Solutions

Electrical conductivity indicates solution concentration and ionization of the dissolved material. Since temperature greatly affects ionization, conductivity measurements are temperature dependent and are normally corrected to read what they would be at 25°C.

A. Standardized to 25°C

Conductivity is measured with great accuracy in the Ultrameter II using a method that ignores fill level, electrolysis, electrode characteristics, etc., and features a microprocessor to perform temperature compensation. In simpler instruments, conductivity values are usually assigned an average correction similar to that of KCl solutions for correction to 25°C. The correction to an equivalent KCl solution is a standard set by chemists that standardizes the measurements and allows calibration with precise KCl solutions. In the Ultrameter II, this correction can be set to other solutions or tailored for special measurements or applications.

B. Tempco Variation

Most conductivity instruments use an approximation of the temperature characteristics of solutions, perhaps even assuming a constant value. The value for KCl is often quoted simply as 2%/°C. In fact, KCl tempco

varies with concentration and temperature in a non-linear fashion. Other solutions have more variation still. The Ultrameter II uses corrections that change with concentration and temperature instead of single average values. See Chart 1.

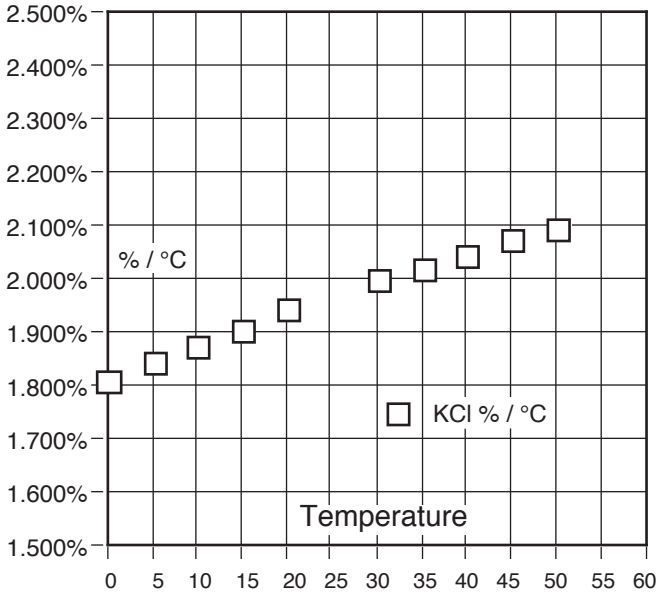

Chart 1

C. An Example of 2 different solution selections and the resulting compensation

How much error results from treating natural water as if it were KCl at 15°C?

A tap water solution should be compensated as 442 with a tempco of 1.68 %/°C, where the KCl value used would be 1.90 %/°C.

Suppose a measurement at 15°C/59°F is 900 microsiemens of true uncompensated conductivity.

Using a 442 correction of 10 (degrees below 25) x 1.68% indicates the solution is reading 16.8% low. For correction, dividing by (.832) yields 1082 microsiemens as a compensated reading.

A KCl correction of 10 (degrees below 25) x 1.9% indicates the solution is reading 19% low. Dividing by (.81) yields 1111 microsiemens for a compensated reading. The difference is 29 out of 1082 = 2.7%.

D. A Chart of Comparative Error

In the range of 1000 μS , the error using KCl on a solution that should be compensated as NaCl or as 442, is illustrated in the graph below.

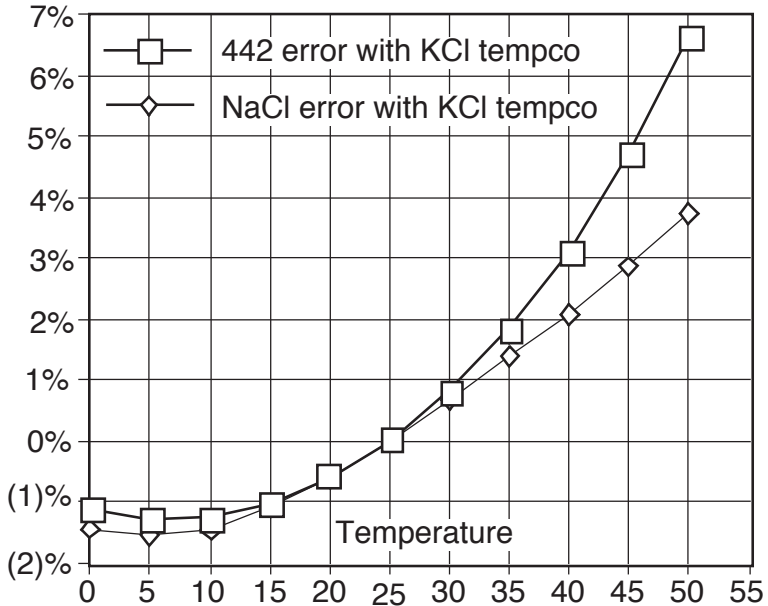

Chart 2

Users wanting to measure natural water based solutions to 1% would have to alter the internal compensation to the more suitable preloaded “442” values or stay close to 25°C. Users who have standardized to KCl-based compensation may want to stick with it, regardless of increasing error as you get further from 25°C. The Ultrameter II will provide the repeatability and convertibility of data necessary for relative values for process control.

E. Other Solutions

A salt solution like sea water or liquid fertilizer acts like NaCl. An internal correction for NaCl can be selected for greatest accuracy with such solutions. Many solutions are not at all similar to KCl, NaCl or 442. A sugar solution, or a silicate, or a calcium salt at a high or low temperature may require a “User” value peculiar to the application to provide readings close to the true compensated conductivity.

Clearly, the solution characteristics should be chosen to truly represent the actual water under test for rated accuracy of $\pm 1\%$. Many industrial applications have historically used relative measurements seeking a

number to indicate a certain setpoint or minimum concentration or trend. The Ultrameter II gives the user the capability to collect data in “KCl conductivity units” to compare to older published data, in terms of NaCl or 442, or as appropriate. The Ultrameter II can be used to reconcile data taken with other compensation assumptions, especially with its ability to allow custom characteristics through the USER mode.

XXI. CONDUCTIVITY CONVERSION to TOTAL DISSOLVED SOLIDS (TDS)

Electrical conductivity indicates solution concentration and ionization of the dissolved material. Since temperature greatly affects ionization, conductivity measurements are temperature dependent and are normally corrected to read what they would be at 25°C (ref. Temperature Compensation, pg. 37).

A. How it's Done

Once the effect of temperature is removed, the compensated conductivity is a function of the concentration (TDS). Temperature compensation of the conductivity of a solution is performed automatically by the internal processor with data derived from chemical tables. Any dissolved salt at a known temperature has a known ratio of conductivity to concentration. Tables of conversion ratios referenced to 25°C have been published by chemists for decades.

B. Solution Characteristics

Real world applications have to measure a wide range of materials and mixtures of electrolyte solutions. To address this problem, industrial users commonly use the characteristics of a standard material as a model for their solution, such as KCl, which is favored by chemists for its stability.

Users dealing with sea water, etc., use NaCl as the model for their concentration calculations. Users dealing with freshwater work with mixtures including sulfates, carbonates and chlorides, the three predominant components (anions) in freshwater that the Myron L Company calls “natural water”. These are modeled in a mixture called “442™” which the Myron L Company markets for use as a calibration standard, as it does standard KCl and NaCl solutions.

The Ultrameter II contains algorithms for these 3 most commonly referenced compounds. The solution type in use is displayed on the left. Besides KCl, NaCl, and 442, there is the “USER” choice. The benefit of USER is that one may enter the temperature compensation and TDS ratio by hand, greatly increasing accuracy of

readings for a specific solution. That value remains a constant for all measurements, and should be reset for different dilutions or temperatures.

C. When does it make a lot of difference?

First, the accuracy of temperature compensation to 25°C determines the accuracy of any TDS conversion. Assume we have industrial process water to be pretreated by RO. Assume it is 45°C and reads 1500 μS uncompensated.

1. If NaCl compensation is used, an instrument would report 1035 μS compensated, which corresponds to 510 ppm NaCl.
2. If 442 compensation is used, an instrument would report 1024 μS compensated, which corresponds to 713 ppm 442.

The difference in values is 40%.

In spite of such large error, some users will continue to take data in the NaCl mode because their previous data gathering and process monitoring was done with an older NaCl referenced device.

Selecting the correct Solution Type on the Ultrameter II will allow the user to attain true TDS readings that correspond to evaporated weight. If none of the 3 standard solutions apply, the User mode must be used. Temperature Compensation (Tempco) and TDS Derivation below, details the USER mode.

XXII. TEMPERATURE COMPENSATION (Tempco) and TDS DERIVATION

The Ultrameter II contains internal algorithms for characteristics of the 3 most commonly referenced compounds. The solution type in use is displayed on the left. Besides KCl, NaCl, and 442, there is the "USER" choice. The benefit of USER mode is that one may enter the tempco and TDS conversion values of a unique solution via the keypad.

A. Conductivity Characteristics

When taking conductivity measurements, the Solution Selection determines the characteristic assumed as the instrument reports what a measured conductivity would be if it were at 25°C. The characteristic is represented by the tempco, expressed in %/°C. If a solution of 100 μS at 25°C increases to 122 μS at 35°C, then a 22% increase has occurred

over this change of 10°C. The solution is then said to have a tempco of 2.2 %/°C.

Tempco always varies among solutions because it is dependent on their individual ionization activity, temperature and concentration. This is why the Ultrameter II features mathematically generated models for known salt characteristics that also vary with concentration and temperature.

B. Finding the Tempco of an Unknown Solution

One may need to measure compensated conductivity of some solution unlike any of the 3 standard salts. In order to enter a custom fixed tempco for a limited measurement range, enter a specific value through the “USER” function. The tempco can be determined by 2 different methods:

1. Heat or cool a sample of the solution to 25°C, and measure its conductivity. Heat or cool the solution to a typical temperature where it is normally measured. After selecting USER function, set the tempco to 0 %/°C as in Disabling Temperature Compensation, pg. 13 (No compensation). Measure the new conductivity and the new temperature. Divide the % decrease or increase by the 25°C value. Divide that difference by the temperature difference.
2. Heat or cool a sample of the solution to 25°C, and measure its conductivity. Change the temperature to a typical measuring temperature. Set the tempco to an expected value as in User Programmable Temperature Compensation, pg. 12. See if the compensated value is the same as the 25°C value. If not, raise or lower the tempco and measure again until the 25°C value is read.

C. Finding the TDS Ratio of an Unknown Solution

Once the effect of temperature is removed, the compensated conductivity is a function of the concentration (TDS). There is a ratio of TDS to compensated conductivity for any solution, which varies with concentration. The ratio is set during calibration in USER mode as in section User Programmable Conductivity to TDS Ratio, pg. 13. A truly unknown solution has to have its TDS determined by evaporation and weighing. Then the solution whose TDS is now known can be measured for conductivity and the ratio calculated. Next time the same solution is to be measured, the ratio is known.

XXIII. pH and ORP (6P)

A. pH (6P)

1. pH as an Indicator (6P)

pH is the measurement of Acidity or Alkalinity of an aqueous solution. It is also stated as the Hydrogen Ion activity of a solution. pH measures the effective, not the total, acidity of a solution.

A 4% solution of acetic acid (pH 4, vinegar) can be quite palatable, but a 4% solution of sulfuric acid (pH 0) is a violent poison. pH provides the needed quantitative information by expressing the degree of activity of an acid or base.

In a solution of one known component, pH will indicate concentration indirectly. However, very dilute solutions may be very slow reading, just because the very few ions take time to accumulate.

2. pH Units (6P)

The acidity or alkalinity of a solution is a measurement of the relative availabilities of hydrogen (H^+) and hydroxide (OH^-) ions. An increase in (H^+) ions increases acidity, while an increase in (OH^-) ions increases alkalinity. The total concentration of ions is fixed as a characteristic of water, and balance would be 10^{-7} mol/liter (H^+) and (OH^-) ions in a neutral solution (where pH sensors give 0 voltage).

pH is defined as the negative logarithm of hydrogen ion concentration. Where (H^+) concentration falls below 10^{-7} , solutions are less acidic than neutral, and therefore are alkaline. A concentration of 10^{-9} mol/liter of (H^+) would have 100 times less (H^+) ions than (OH^-) ions and be called an alkaline solution of pH 9.

3. The pH Sensor (6P)

The active part of the pH sensor is a thin glass surface that is selectively receptive to hydrogen ions. Available hydrogen ions in a solution will accumulate on this surface and a charge will build up across the glass interface. The voltage can be measured with a very high impedance voltmeter circuit; the dilemma is to connect the voltmeter to solution on each side.

The glass surface encloses a captured solution of potassium chloride holding an electrode of silver wire coated with silver chloride. This is the most inert connection possible from a metal to an electrolyte. It can still produce an offset voltage, but using the same materials to connect to the solution on the other side of the membrane causes the 2 equal offsets to cancel.

The problem is, on the other side of the membrane is an unknown test solution, not potassium chloride. The outside electrode, also called the Reference Junction, is of the same construction with a porous plug in place of a glass barrier to allow the junction fluid to contact the test solution without significant migration of liquids through the plug material. Figure 33 shows a typical 2 component pair. Migration does occur, and this limits the lifetime of a pH junction, from depletion of solution inside the reference junction or from contamination. The junction may be damaged if dried out because insoluble crystals may form in a layer, obstructing contact with test solutions. See pH/ORP, pg. 43.

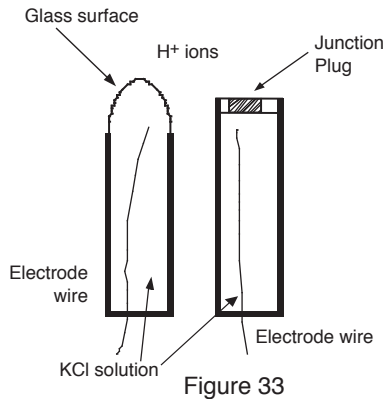

4. The Myron L Integral pH Sensor (6P)

The sensor in the Ultrameter II (see Figure 34) is a single construction in an easily replaceable package. The sensor body holds an oversize solution supply for long life. The reference junction “wick” is porous to provide a very stable, low permeable interface, and is located under the glass pH sensing electrode. This construction combines all the best features of any pH sensor known.

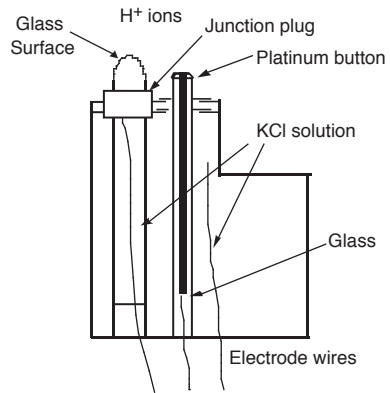

5. Sources of Error (6P)

The basics are presented in pH/ORP, pg. 43.

a. Reference Junction

The most common sensor problem will be a clogged junction because a sensor was allowed to dry out. The symptom is a drift in the “zero” setting at 7 pH. This is why the Ultrameter II does not allow more than 1 pH unit of offset during calibration. At that point the junction is unreliable.

b. Sensitivity Problems

Sensitivity is the receptiveness of the glass surface. A film on the surface can diminish sensitivity and cause a long response time.

c. Temperature Compensation

pH sensor glass changes its sensitivity slightly with temperature, so the further from pH 7 one is, the more effect will be seen. A pH of 11 at 40°C would be off by 0.2 units. The Ultrameter II senses the sensor well temperature and compensates the reading.

B. ORP/Oxidation-Reduction Potential/REDOX (6P)

1. ORP as an Indicator (6P)

ORP is the measurement of the ratio of oxidizing activity to reducing activity in a solution. It is the potential of a solution to give up electrons (oxidize other things) or gain electrons (reduce).

Like acidity and alkalinity, the increase of one is at the expense of the other, so a single voltage is called the Oxidation-Reduction Potential, with a positive voltage showing, a solution wants to steal electrons (oxidizing agent). For instance, chlorinated water will show a positive ORP value.

2. ORP Units (6P)

ORP is measured in millivolts, with no correction for solution temperature. Like pH, it is not a measurement of concentration directly, but of activity level. In a solution of only one active component, ORP indicates concentration. Also, as with pH, a very dilute solution will take time to accumulate a readable charge.

3. The ORP Sensor (6P)

An ORP sensor uses a small platinum surface to accumulate charge without reacting chemically. That charge is measured relative to the solution, so the solution “ground” voltage comes from a reference junction - same as the pH sensor uses.

4. The Myron L ORP Sensor (6P)

Figure 34, pg. 44, shows the platinum button in a glass sleeve. The same reference is used for both the pH and the ORP sensors. Both pH and ORP will indicate 0 for a neutral solution. Calibration at zero compensates for error in the reference junction.

A zero calibration solution for ORP is not practical, so the Ultrameter II uses the offset value determined during calibration to 7 in pH calibration (pH 7 = 0 mV). Sensitivity of the ORP surface is fixed, so there is no gain adjustment either.



5. Sources of Error (6P)

The basics are presented in pH/ORP, pg. 43, because sources of error

are much the same as for pH. The junction side is the same, and though the platinum surface will not break like the glass pH surface, its protective glass sleeve can be broken. A surface film will slow the response time and diminish sensitivity. It can be cleaned off with detergent or acid, as with the pH glass.

XXIV. SOFTWARE VERSION

Contact the Myron L Company to see if a software upgrade is available.

- 1. Press  key.
- 2. Press  key until three numbers are displayed as shown in Figure 35.
- 3. Press  key, instrument will time out in ~15 seconds.

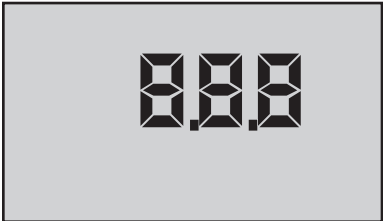

Figure 35

XXV. GLOSSARY

Anions	Negatively charged ions. See Solution Characteristics, pg. 40.
Algorithm	A procedure for solving a mathematical problem. See Temperature Compensation and TDS Derivation, pg. 41.
Logarithm	An arithmetic function. See pH Units, pg. 43.
ORP	Oxidation-Reduction Potential or REDOX, See ORP/ Oxidation-Reduction Potential/REDOX, pg. 45.
TDS	Total Dissolved Solids or the Total Conductive Ions in a solution. See Conductivity Conversion to TDS, pg. 40.
Tempco	Temperature Compensation See Temperature Compensation, pg. 37.
USER	A mode of operation that allows the instrument user (operator) to set a tempco and/or a TDS factor for their specific solution type. See Temperature Compensation, pg. 37 and Temperature Compensation (Tempco) and TDS Derivation, pg. 41.

For details on specific areas of interest refer to the Table of Contents.

XXVI. ADDENDUM

XXVII. NOTES

Myron L COMPANY
2450 Impala Drive
Carlsbad, CA 92010-7226
USA
Tel: +1-760-438-2021
Fax: +1-760-931-9189

**E-Mail: info@myronl.com
techquestions@myronl.com**

www.myronl.com

Made In USA