

# Series WT

## ELECTRONIC METERING PUMPS

Installation,  
Operation, &  
Maintenance  
Instruction

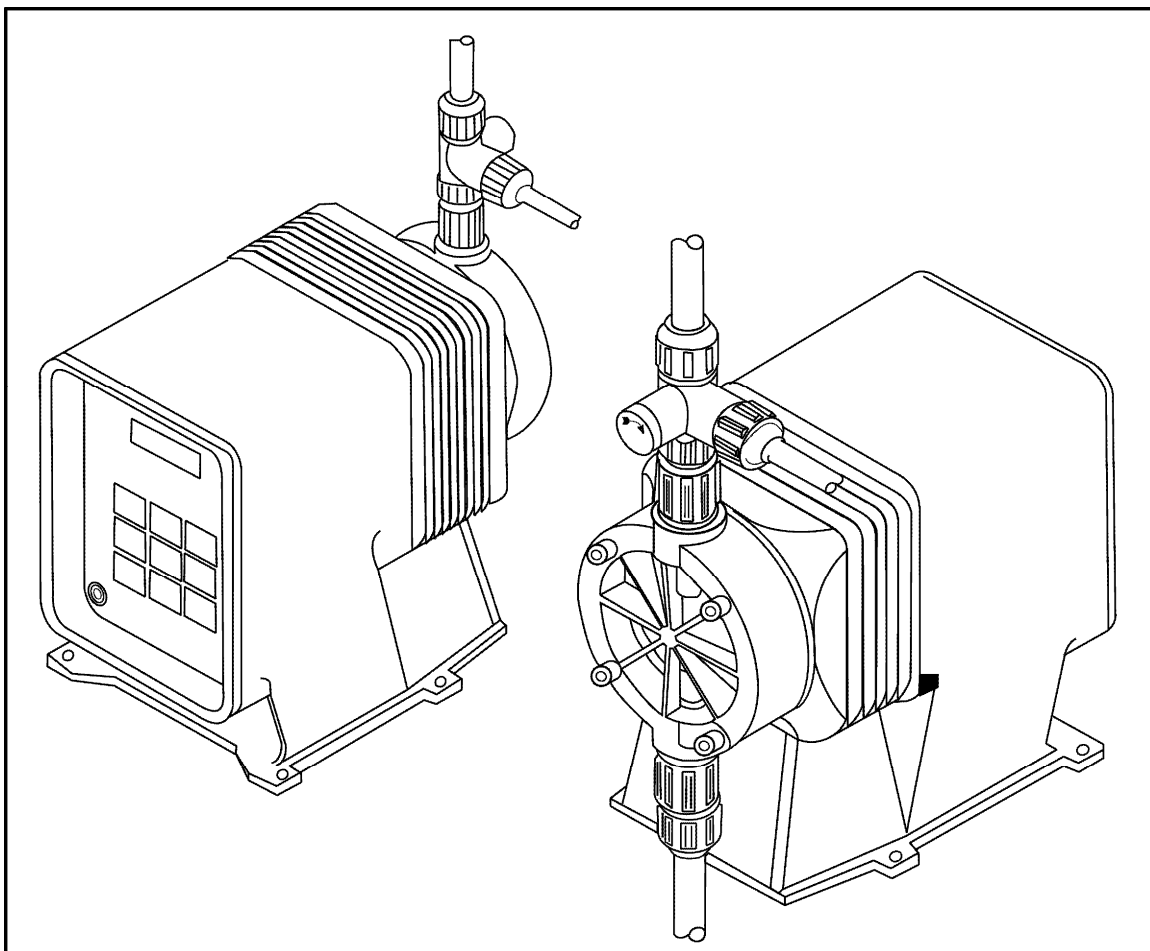

READ ALL WARNINGS CAREFULLY  
BEFORE INSTALLING

## SAFETY INSTRUCTIONS



WHEN USING CHEMICAL FEED PUMPS, BASIC SAFETY PRECAUTIONS SHOULD ALWAYS BE FOLLOWED TO REDUCE RISK OF FIRE, ELECTRIC SHOCK, AND PERSONAL INJURY. FAILURE TO FOLLOW THESE INSTRUCTIONS COULD RESULT IN DEATH OR SERIOUS INJURY.

## GENERAL SAFETY CONSIDERATIONS

- Always wear protective clothing including gloves and safety glasses when working on or near chemical metering pumps.
- Inspect tubing regularly for cracking or deterioration and replace as necessary. **(Always wear protective clothing and safety glasses when inspecting tubing.)**
- When the pump is exposed to direct sunlight use U.V. resistant tubing.
- Follow directions and warnings provided with the chemicals from the chemical manufacturer. The customer is responsible for determining chemical compatibility with the chemical feed pump.
- Secure chemicals and metering pumps making them inaccessible to children and pets.
- Make sure voltage on chemical metering pump matches the voltage at the installation.
- Do not cut plug off electrical cord or the ground lug – consult a licensed electrician for proper installation.
- Pump is **NOT** to be used to handle **flammable liquids**.
- During the approval process, water was used for testing purposes. The use of this product with certain chemicals may present hazardous conditions that are beyond the scope of this approval. Contact your chemical provider / safety agency for further information.

## SAFETY OPERATING PROCEDURES

- All pumps are tested with water before shipment. Remove head and dry thoroughly if you are pumping chemicals that will react with water (e.g., sulfuric acid). Valve seats, ball checks, gaskets and diaphragms should also be dried.
- Finger tighten connections on the pump head. **DO NOT USE A WRENCH**. Ptfе tape is only necessary when the pump is equipped with NPT connections.
- Before repairing or moving the pump, disconnect the power cord or turn off power to the pump. Depressurize the system and drain chemical(s). **(Always wear protective clothing and safety glasses when working on a metering pump.)**
- Always consult a licensed plumber and electrician before installation and make sure to conform to local codes.
- Consult with local health officials and a qualified water conditioning specialist when treating potable water.
- Be sure to depressurize the system prior to hooking up or disconnecting a metering pump.
- If the point of injection is lower than the chemical tank and pump, install an anti-siphon valve.
- **DO NOT MODIFY** the pump. This poses a potentially dangerous situation and will void the warranty.

# Table of Contents

1.	INTRODUCTION .....	5
1.1	PRINCIPLE OF OPERATION .....	5
1.2	MATERIALS OF CONSTRUCTION .....	5
1.3	MANUFACTURER'S PRODUCT WARRANTY .....	5
1.4	EUROPEAN TECHNICAL FILE LOCATION .....	6
1.5	UNPACKING THE PUMP .....	6
1.6	PRECAUTIONS FOR OPERATION.....	7
1.7	INSTALLATION, PIPING AND WIRING .....	9
1.7.1	MOUNTING .....	9
1.7.2	PIPING.....	10
1.7.3	WIRING.....	11
1.8	COOLING TOWER INSTALLATION .....	12
1.8.1	FLOW ASSEMBLY .....	12
2.	CONTROLS .....	14
2.1	TOUCH PAD DEFINITIONS.....	15
3.	OPERATION .....	16
3.1	POWER UP (INITIALIZATION).....	16
3.2	PUMP SETUP .....	16
3.2.1	K-FACTOR SETUP .....	18
3.2.2	PRIMING THE PUMP .....	19
3.3	PROGRAMMING THE PUMP .....	19
3.3.1	RATE .....	19
3.3.2	PUMP COUNT.....	20
3.3.3	PUMP TIMER .....	20
3.3.4	BLEED COUNT .....	21
3.3.5	BLEED TIMER.....	21
3.4	OPERATING MODES .....	22
3.4.1	OFF (STANDBY).....	22
3.4.2	CONTROL .....	22
3.4.3	FORCED - ON .....	24
3.5	LOSS OF POWER .....	25
3.5.1	NO FLOW .....	25
3.6	SPECIFICATIONS.....	26
3.7	OPTIONS.....	27
3.8	FACTORY INITIALIZATION .....	27
4.	MAINTENANCE .....	29
4.1	ROUTINE MAINTENANCE .....	29
4.2	DISASSEMBLY AND ASSEMBLY .....	29
4.2.1	DIAPHRAGM REMOVAL.....	29
4.2.2	DIAPHRAGM REPLACEMENT .....	30
4.2.3	VALVE REPLACEMENT.....	30
5.	TROUBLESHOOTING .....	31
6.	ERROR CODES.....	33

## Conventions:

The following conventions are used in this document.



**A WARNING DEFINES A CONDITION THAT COULD CAUSE DAMAGE TO BOTH THE EQUIPMENT AND THE PERSONNEL OPERATING IT. PAY CLOSE ATTENTION TO ANY WARNING.**



Notes are general information meant to make operating the equipment easier.



Tips have been included within this bulletin to help you run the equipment in the most efficient manner possible. These "Tips" are drawn from the knowledge and experience of our staff engineers, and input from the field.



This is a procedure heading. A Procedure Heading indicates the starting point for a procedure within a specific section of this manual.

The following standards have been developed to make using this manual easier. Formatting certain sections of text so that they stand out from the main body alerts the reader that there is some item of interest within a specific paragraph by drawing attention to:

- Text that has been formatted ***bold*** and *italicized* (e.g., ***Figure 2-C***) indicates reference text.
- Text that has been formatted in UPPER CASE letters, and surrounded by brackets [ ] indicates a button to be pressed (e.g., [TIMER]).
- Text that has been formatted in **Title Case** letters, using the **Arial - Bold** Font indicates a mode selection (e.g., **Forced On**).

# 1. Introduction

These installation, operation and maintenance instructions cover your electronic metering pump. Refer to the pump nameplate to determine the actual model.

## 1.1 Principle of Operation

The Series WT was designed specifically for the control of conductivity and the addition of an inhibitor in an open air Water Tower. The WT series uses pulses from a water meter to control the pump and bleed relay output. The pump monitors the output from the water meter. It compares the accumulated count value to count set points for both the pump and bleed relay. When the setpoint is reached, the output is activated for a specified amount of time.

The pump can accept either a dry contact or open collector water meter output. The software includes a “K” Factor that will convert multiple counts into a volumetric unit (e.g., gallons or liters).

This pump uses an electromagnetic drive mechanism (solenoid) which is connected to a diaphragm. When the solenoid is pulsed by the control circuit, it displaces the diaphragm that, through the use of check valves, moves the fluid out the discharge under pressure. When the solenoid is de-energized it returns the diaphragm and pulls more fluid into the pump head and the cycle repeats.

## 1.2 Materials of Construction

The wetted materials (those parts that contact the solution being pumped) available for construction are polypropylene, PVC, SAN, Hypalon, Viton, Pffe, 316 Stainless Steel, PVDF, Ceramic, and Alloy C. These materials are very resistant to most chemicals. There are some chemicals, such as strong acids or organic solvents, which cause deterioration of some elastomer and plastic parts, such as diaphragm, valve seat, or head. Consult a Chemical Resistance Guide or Supplier for information on chemical compatibility.

Various manufacturers of plastics, elastomers and pumping equipment publish guidelines that aid in the selection of wetted materials for pumping commercially available chemicals. Two factors must always be considered when using an elastomer or plastic part to pump chemicals. They are:

1. The temperature of service: Higher temperatures increase the effect of chemicals on wetted materials. The increase varies with the material and the chemical being used. A material quite stable at room temperature might be affected at higher temperatures.
2. Material choice: Materials with similar properties may differ greatly from one another in performance when exposed to certain chemicals.

## 1.3 Manufacturer’s Product Warranty

The manufacturer warrants its equipment to be free of defects in material or workmanship. Liability under this policy extends for eighteen (18) months from the date of purchase or one (1) year from the date of installation, whichever comes first. The electronic components will be covered under this policy for a period which extends for twenty four (24) months from the date of purchase. The manufacturer’s liability is limited to repair or replacement of any device or part which is returned, prepaid, to the factory and which is proven defective upon examination. This warranty does not include installation or repair cost and in no event shall the manufacturer’s liability exceed its selling price of such part.

The manufacturer disclaims all liability for damage to its products through improper installation, maintenance, use or attempts to operate such products beyond their functional capacity, intentionally or otherwise, or any unauthorized repair. Replaceable elastomeric parts are expendable and are not covered by any warranty either expressed or implied. The manufacturer is not responsible for consequential or other damages, injuries, or expense incurred through the use of its products.

The above warranty is in lieu of any other warranty, either expressed or implied. The manufacturer makes no warranty of fitness of merchantability. No agent of ours is authorized to make any warranty other than the above.

The European Union Warranty address is listed below, however, please note that the seller should be contacted first.

Pulsafeeder Europe  
Marssteden 68  
7547 AD. Enschede

## 1.4 European Technical File Location

P.O. Box 91  
Washington  
NE37 1YH  
United Kingdom

## 1.5 Unpacking the Pump

Check all equipment for completeness against the order and for any evidence of shipping damage. Shortages and damages should be reported immediately to the carrier and to the manufacturer.

The carton should contain the following:

1. Metering Pump
2. Stiff White Discharge Tubing
3. Clear Flexible Suction Tubing
4. Instruction Manual
5. Injector Valve Assembly
6. Foot Valve/Strainer Assembly
7. Stabilizer Weight (part of Foot Valve/ Strainer assembly)
8. Bleed Valve Assembly

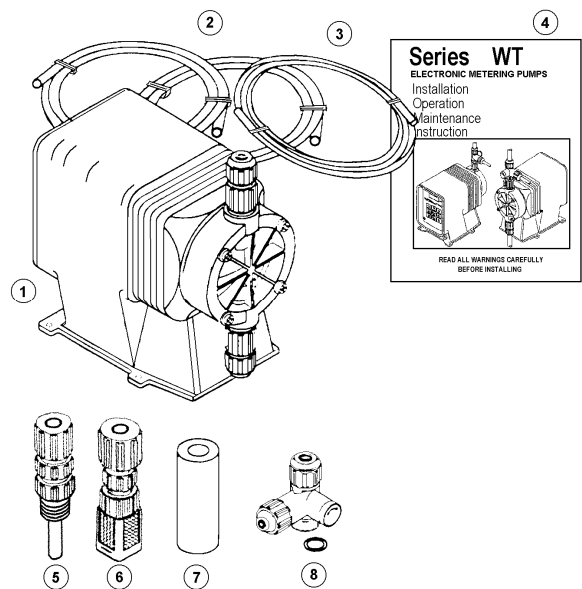
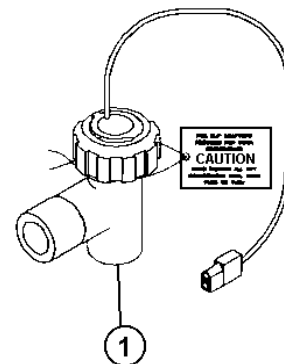

Figure 1

The carton may also include the optional flow switch assembly:



**Make sure that all items have been removed from the shipping carton before it is discarded.**

## 1.6 Precautions for Operation

Each Electronic Metering Pump has been tested to meet prescribed specifications and safety standards. Proper care in handling, installation and operation will help in ensuring a trouble free installation.

**Read these cautionary notes prior to the installation and start-up to achieve the best performance from your Series WT metering pump.**

1. **Important: The Pump must be installed and used with the supplied back pressure/ injection valve. Failure to do so could result in excessive pump output flow.**
2. Handle the pump with care. Dropping or heavy impact may cause not only external damage to the pump, but also to electrical parts inside the pump enclosure.
3. Install the pump in a place where the ambient temperature does not exceed 40°C (104°F) and the relative humidity is below 90%. The pump is water resistant and dust proof by construction and can be used outdoors. **Do not operate the pump submerged.** To avoid high internal pump temperatures, do not operate in direct sunlight.
4. Install the pump in a place convenient for its future maintenance and inspection. Mount the pump in such a manner to prevent vibration.
5. Protective caps must be removed prior to installing tubing onto valve assemblies. Use the correct tubing sizes. Connect the tubing to the suction side securely to prevent the entrance of outside air. Verify that there is no liquid leakage on the discharge side.
6. Be careful to check the voltage of the installation matches the voltage indicated on the pump nameplate. Each pump is equipped with a three-prong plug. Always be sure that the pump is grounded. To disconnect, do not pull the wire, but grip the plug and pull out. Do not use the receptacle in common with heavy electrical equipment that generates surge voltage. A line surge could cause the failure of the electronic circuit inside the pump.
7. Tampering with electrical devices can be potentially hazardous. Always place chemicals and install the pump well out of the reach of children.
8. Never repair or move the metering pump while it is operating. Always disconnect electrical power. **For safety, always wear protective clothing (protective gloves and safety glasses) when working on or near chemical metering pumps.**
9. An air bleed valve is available for all models with a tubing connection. Air purges should be performed when the pump chamber contains no fluid at the time of start-up. As a safety measure, connect the return tubing to the air bleed valve and bypass fluid back to a storage tank or a suitable drain.
10. Chemicals used may be dangerous and should be used carefully and according to warnings on the label. Follow the directions given with each type of chemical. Do not assume chemicals are the same because they look alike. Always store chemicals in a safe location away from children. We cannot be responsible for the misuse of chemicals being fed by the pump. Always have the material safety data sheet (MSDS) available for any fluid being pumped.
11. All pumps are pre-tested with water before shipment. Remove the head and dry thoroughly if you are pumping material that will react with water (e.g., sulfuric acid). Valve seats, ball checks, gaskets, and the diaphragm should also be dried. **Verify that this procedure has been completed prior to placing the pump into service.**
12. Valve cartridges are stamped to indicate fluid flow direction. Always install so that markings read from top to bottom, with the arrow pointing in the direction of flow.
13. When metering hazardous material **DO NOT** use plastic tubing. Use only proper rigid pipe. Consult your supplier for special adapters or valve assemblies.
14. **The pump is NOT to be used to handle or meter flammable liquids or materials.**
15. Standard (white translucent) discharge tubing is not recommended for installations exposed to direct sunlight. Consult your supplier for UV resistant (black) tubing.

16. The factory will not be held responsible for improper installation of the pump, or plumbing. All cautions are to be read thoroughly prior to hook-up and plumbing. For all installations a professional plumber should be consulted. Always adhere to local plumbing codes and requirements.
17. When using the pump with pressurized systems, make sure the pressure of the system does not exceed the maximum pressure rating on the pump nameplate. Be sure to de-pressurize the system prior to hookup or disconnecting the pump.
18. Electronic power modules (i.e. solenoids) are equipped with automatic reset thermal-overload devices and may reset unexpectedly.
19. The pump is designed to operate using a back pressure/injection valve. If the discharge point is below the liquid level of the source or if the discharge pressure is less than the suction pressure, siphoning may occur. To correct this condition, install an anti-siphon valve or other anti-siphon device. Check local regulations that may apply.

## 1.7 Installation, Piping and Wiring

The metering pump should be located in an area that allows convenient connections to both the chemical storage tank and the point of injection. The pump is water resistant and dust proof and can be used outdoors. Do not operate this pump submerged. Avoid continuous temperatures in excess of 40°C (104°F). To do otherwise will result in damage to the pump.

### 1.7.1 Mounting

Typical mounting arrangements are shown in *Figures 2-A, 2-B, & 2-C*.



**Important: The injection point must be higher than the top of the solution supply tank to prohibit gravity feeding, unless suitable back pressure is always present at the injection point. An anti-siphon valve may be installed to prevent gravity feeding.**

1. For wall or shelf mounting refer to *Figure 2-A*. Connect suction tubing to the suction valve of the chemical pump. (The suction valve is the lower valve.) The tubing should be long enough that the foot valve/ strainer assembly hangs about 2-3 inches above the bottom of the chemical (solution) tank. To keep the chemical from being contaminated, the tank should have a cover.
2. Flooded suction mounting (installing the pump at the base of the solution storage tank, *Figure 2-B*) is the most trouble free type of installation and is recommended for very low output requirements. Since the suction tubing is filled with chemical, priming is accomplished quickly and the chance of losing the prime is reduced.

To mount the pump, drill 4 holes of 1/4" diameter in the shelf as shown in the dimension drawing (*Figure 3*). Attach the pump securely using four #10 bolts, nuts and lock washers.

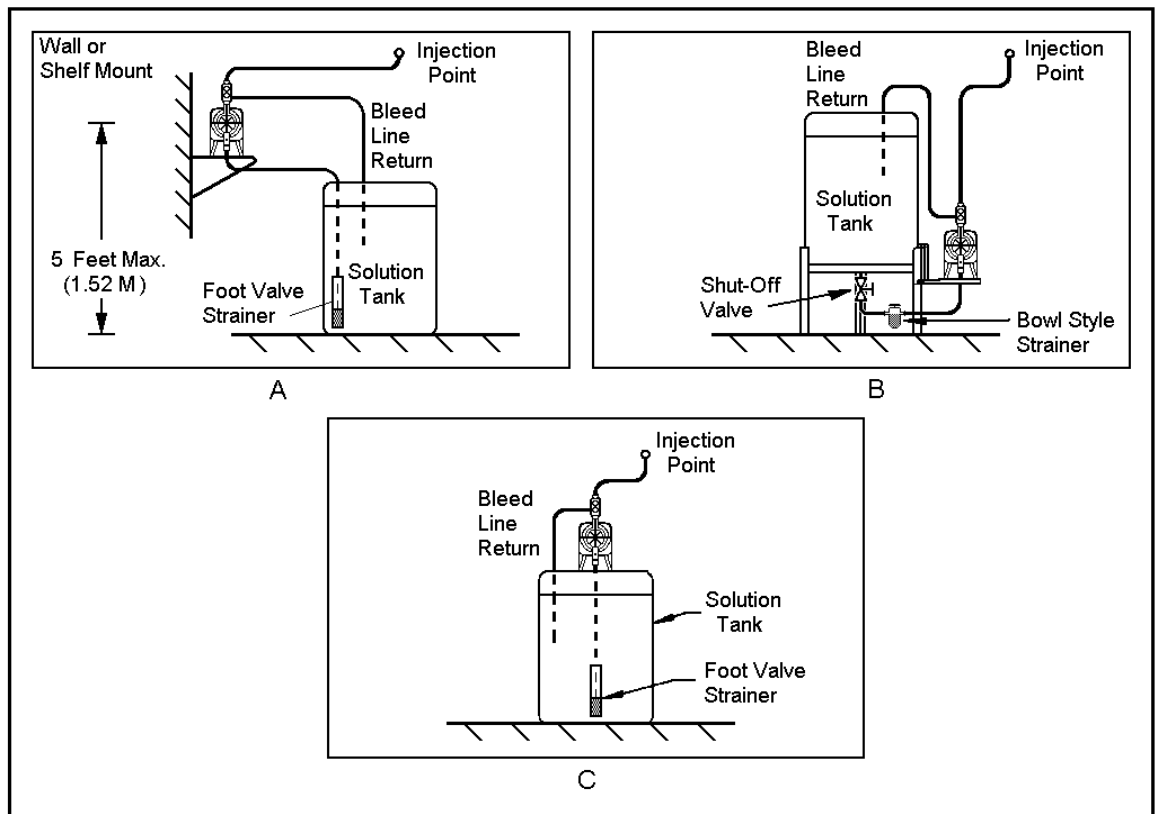
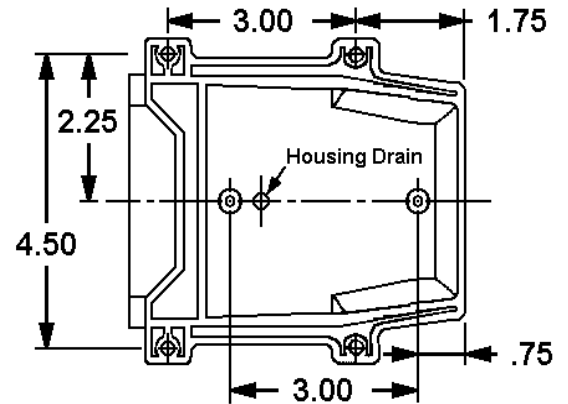

Figure 2

- The pump can be mounted to a wall as shown in *Figure 2-A*. A wall mount bracket kit is available which includes all necessary hardware to mount the pump to the bracket and the bracket to the wall. Mounting dimensions for the pump are provided in *Figure 3*.
- The pump can be mounted on top of a solution tank as shown in *Figure 2-C*. Install the chemical pump on the cover. Insert suction tubing through the center hole and cut the tubing so that the foot valve/strainer hangs about 2-3 inches above the bottom of the tank. Mount the chemical pump rigidly by drilling four 1/4" holes and using four #10 bolts, nuts and lock washers.



*Figure 3*

- Use an anti-siphon valve in the discharge line whenever the fluid pressure in the discharge line is below atmospheric pressure. This can occur if the injection point is on the suction side of a water pump or against a “negative” head.

## 1.7.2 Piping

- Use provided tubing of specified size for connection. Connect tubing securely to prevent chemical leakage or the entrance of outside air. Plastic nuts are used for fittings and should only be hand tightened. NPT suction and discharge valves must **NOT** be over tightened. Hold fittings in place while adding piping and fittings. NPT suction and discharge valves should only be tightened 25 to 35 in. lbs.
- If the air bleed valve assembly is being used, a return line (tubing) should be securely connected and routed back to the storage tank. **To avoid possible injury from chemicals do not attempt to prime using a bleed valve without installing a return line.**
- When the pump is shelf mounted, or top mounted on a tank, suction tubing should be kept as short as possible.
- To maintain metering performance, a back pressure/injection valve is provided. The injection valve must be installed in the discharge line. It is recommended that the back pressure/injection valve be installed at the point of chemical injection.
- If the discharge tubing is going to be exposed to direct sunlight, black tubing should be used instead of the standard (white translucent) tubing supplied with each pump. To obtain UV resistant (black) tubing contact your supplier.

6. To prevent clogging or check valve malfunction, always install a strainer assembly to the end of the suction tubing. (*Figure 2-C*). This foot valve/strainer assembly should always be installed 2 to 3 inches above the bottom of the chemical tank. This will help prevent clogging the strainer with any solids that may settle on the tank bottom. The chemical tank and foot valve/strainer should be cleaned regularly, to ensure continuous trouble operation. If the chemical being pumped regularly precipitates out of solution or does not dissolve easily or completely (e.g. calcium hydroxide), a mixer should be used in the chemical tank. These are available in many motor configurations and mountings. To obtain a mixer, contact your supplier.
7. A flooded suction (tank liquid level always at a higher elevation than the pump) is recommended when pumping sodium hypochlorite (NaOCl) and hydrogen peroxide (H<sub>2</sub>O<sub>2</sub>) etc. which are liable to produce air bubbles. Maintaining a low liquid temperature will also help eliminate this problem.
8. Pipe corrosion can result if dilution at the injection point does not occur rapidly. This problem can be prevented by observing this simple rule: Install an injection fitting so that the end is in the center of the flow stream of the line being treated. Trim the injector tip as required. Refer to *Figure 4*.



**Extended injection assemblies are available for large water lines. Consult your supplier for more information.**

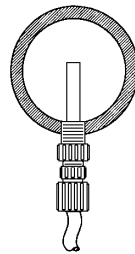

*Figure 4*

### 1.7.3 Wiring

1. The metering pump should be wired to an electrical source which conforms to those on the pump nameplate. (Applying higher voltage than the pump is rated for will damage the internal circuit.)



**RISK OF ELECTRICAL SHOCK. THIS PUMP IS SUPPLIED WITH A THREE PRONG GROUNDING TYPE POWER PLUG. TO REDUCE RISK OF ELECTRICAL SHOCK, CONNECT ONLY TO A PROPERLY GROUNDED, GROUNDING TYPE RECEPTACLE.**

2. In the electronic circuit of the control unit, protection from surge voltage is made by means of surge absorbing elements and high voltage semiconductors. Nevertheless, excessive surge voltage may cause failure in some areas. Therefore the pump should never share a branch circuit that supports heavy electrical equipment (e.g. large motors). The use of a surge suppression device in line with the pump is strongly recommended! The device should meet or exceed the following minimum requirements:

Response:	<1nS
Energy Dissipation:	400 Joules
Protection:	L-N, L-G, N-G

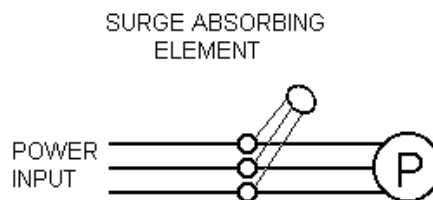
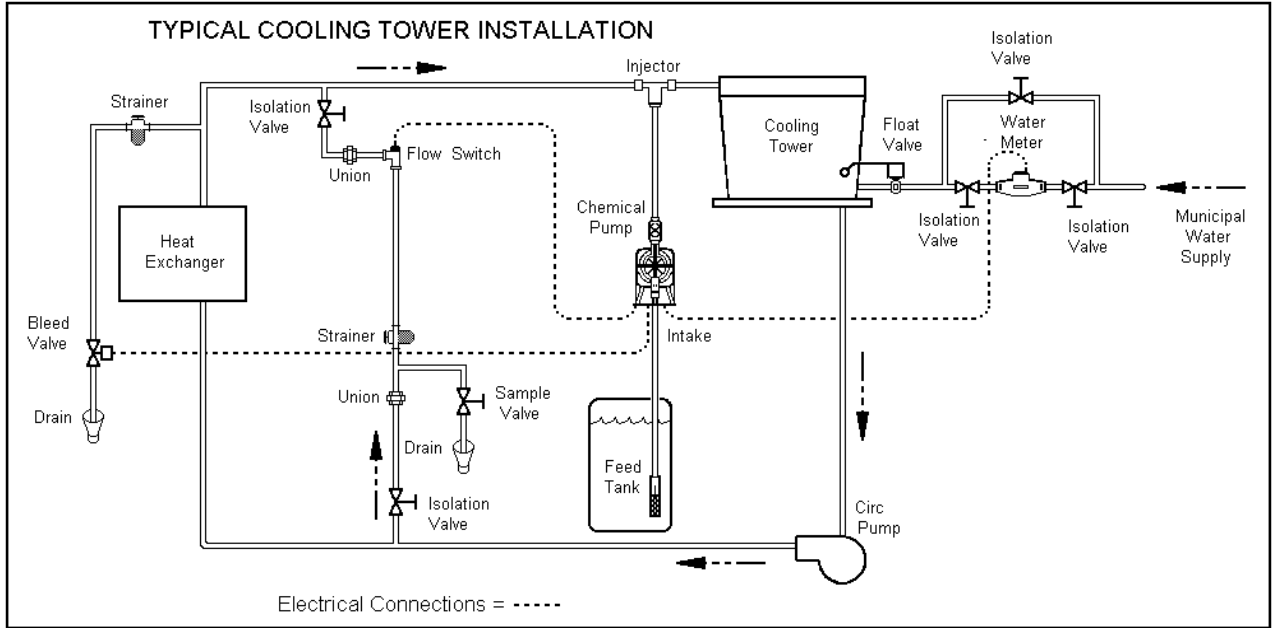

*Figure 5*

## 1.8 Cooling Tower Installation

Install the pump in the Cooling Tower system as depicted in *Figure 6* below.

Refer to section 1.7.1 for pump installation details. Make sure that all fittings and connections are secure. Plumbing of the flow switch and water meter is critical to the successful operation of the pump. Installation should comply with all national state and local codes.

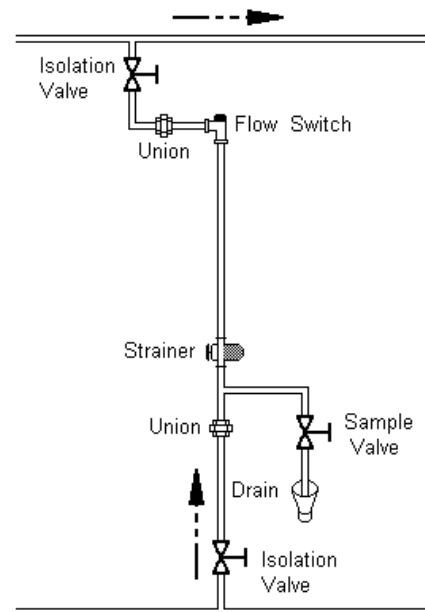

*Figure 6*

Refer to *Figure 6* above to set up your Chemical Pump. Make sure all fittings and connections are secure.

### 1.8.1 Flow Assembly

A sample line with between 1 to 5GPM (4 to 19LPM) of flow is required for installation of the Flow Switch. It is a good idea to install isolation valves and unions around these items to allow easy service. An up-stream strainer should be installed to block debris that could foul the switch. If the pump is to inject directly into this line (not recommended), always use a back check valve to prevent chemical backup.



*Figure 7*

### 1.8.1.1 Flow Switch (Optional)

The Flow Switch accessory consists of a clear body, a red flow poppet and a sensing cap. Flow causes the poppet to rise activating a switch in the sensing cap.

Install the Flow Switch in the sample stream piping so that the cap is at the top and the flow poppet is vertical. Flow should enter the bottom and exit the top to the right or left. There must be at least 1 GPM (3.81 LPM) of flow across the switch for it to activate properly. It is also advisable to check the line to assure that siphoning will not occur (holding the flow switch).

The Flow Switch to pump cable length should not exceed 60ft (18m).

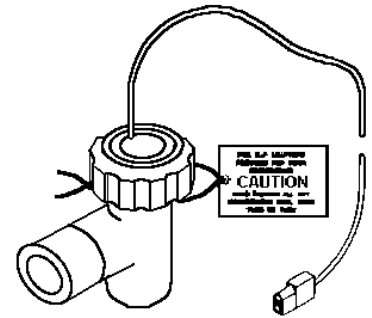

### 1.8.1.2 Water Meter (Accessory)

Install the Water Meter in the makeup line in accordance with the manufacture's instructions. To operate properly with the pump the water meter must generate a dry contact switch closure or open collector signal (sinking) in proportion to the flow (e.g., 1 pulse per 100 gallon). If the water meter generates more than one pulse per gallon its "K" Factor should be set. Refer to the **Operation Section** for details on configuring the "K" Factor. Refer to the **Wiring and Connections** section for water meter wiring details.

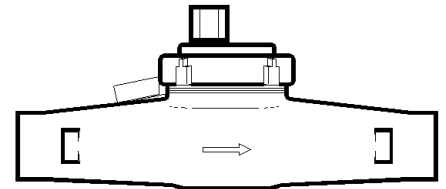

The Water Meter to pump cable length should not exceed 60ft (18m).

## 2. Controls

The Series WT uses a microprocessor to control its operation. All adjustments and changes to pump operation are made through the 9-key touch-pad (refer to *Figure 8*). The pump displays operating information through numeric and status LED's.

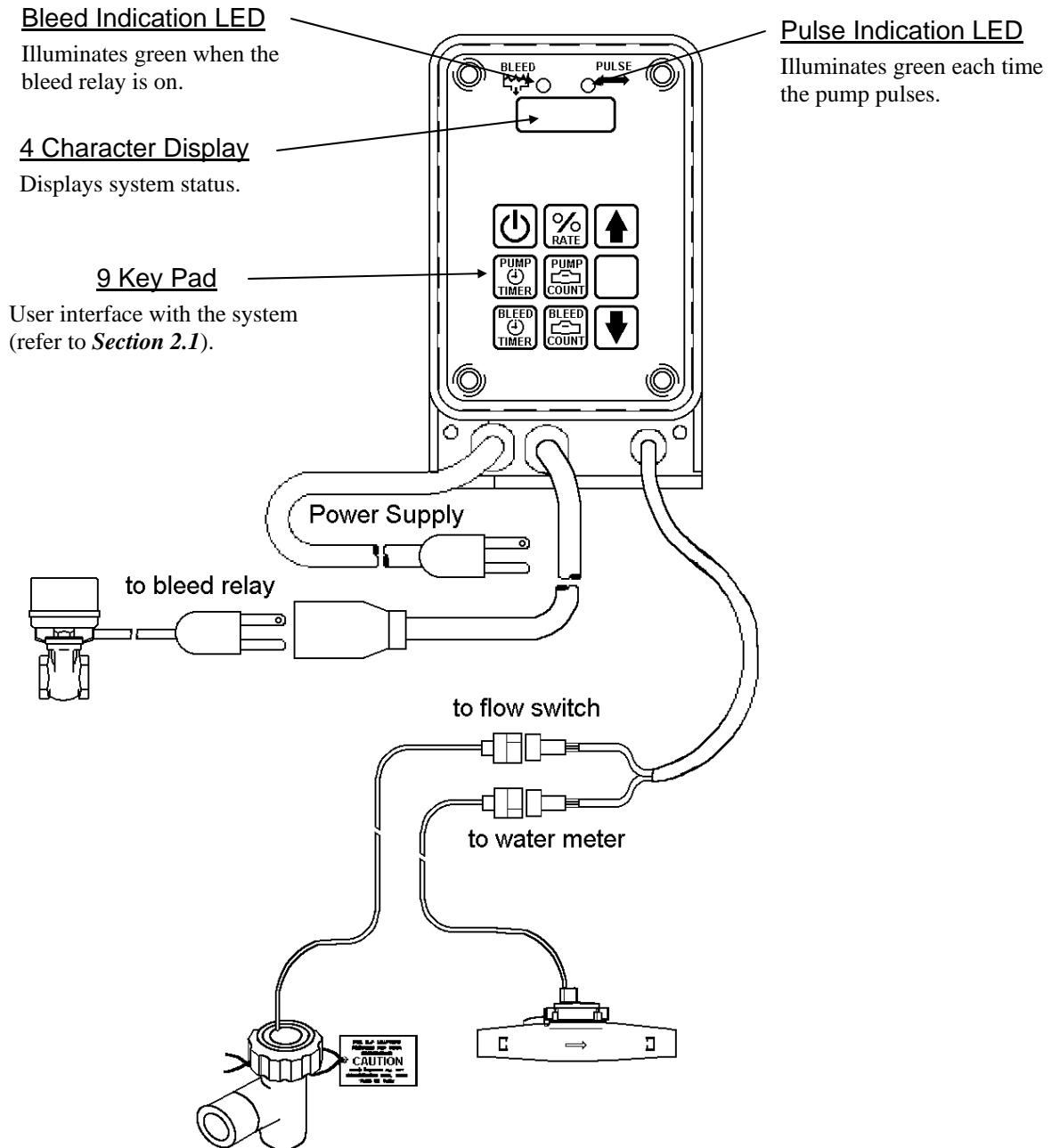

*Figure 8*

## 2.1 Touch Pad Definitions



### ON/Standby

Activates/Deactivates Automatic Control (Control Mode) – display reflects count accumulator.  
Forces pump on.  
Forces pump off.



### UP/DOWN

Used in conjunction with a function key to increase [UP] or decrease [DOWN] the displayed value by a fixed amount.



### PUMP COUNT

Sets the number of water meter counts (or gallons or liters if a “K” factor is set) to accumulate before running the pump.  
Range = 0 – 9999  
10 count increase with [UP] key press.  
100 count auto-increase with [UP] key hold.  
1 count decrease with [DOWN] key press.  
10 count auto-decrease with [DOWN] key hold.



### PUMP TIMER

Sets the pumps run time in MM:SS format.  
Range = 00:00 to 59:59  
1 second per single [UP]/[DOWN] key press.  
1 minute auto-increment when key is held.



### RATE

Sets the pump stroke rate (in percent).  
Range = 0 – 100%  
1% per [UP] / [DOWN] key press.  
10% auto-increment when key is held.



### BLEED COUNT

Sets the number of water meter counts (or gallons or liters if a “K” factor is set) to accumulate before running the Bleed Relay.  
Range = 0 – 9999  
10 count increase with [UP] key press.  
100 count auto-increase with [UP] key hold.  
1 count decrease with [DOWN] key press.  
10 count auto-decrease with [DOWN] key hold.



### BLEED TIMER

Sets the Bleed relay run time in MM:SS format.  
Range = 00:00 to 59:59  
1 second per [UP] / [DOWN] key press.  
1 minute auto-increment when key is held.

## 3. Operation

This section describes initialization and operation of the Series WT pump.

### 3.1 Power Up (Initialization)



**BEFORE APPLYING POWER, INSURE THAT THE DEVICES BEING CONTROLLED ARE NOT IN A POSITION TO CAUSE HARM OR DAMAGE IF ACTIVATED UPON INITIAL STARTUP.**

1. With the pump installed and connected to the Cooling Tower as discussed in the previous section, apply power.
2. When power is applied, the following occurs:
  - All of the display elements are illuminated for 1 second.
  - The configuration number is displayed for 1 second.
  - The software revision number is displayed as "r X X r" for 1 second.

This sequence is displayed as follows:

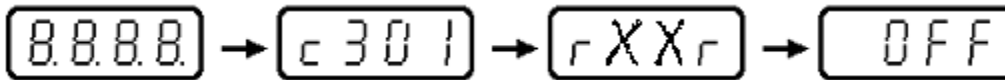

3. The controller then determines its last mode of operation (i.e., **Off (Standby)**, **Control**, **Forced On** and **Forced On Run**). Then, based on the mode, it will display:
  - OFF (for **Off (Standby)**),
  - ON (for **Forced On Run**), or
  - Accumulator Status (e.g., 'Bled / 10 / Feed / 10' for **Control**), or
  - Pump rate percentage (e.g. '75' for **Forced On-Run**)

### 3.2 Pump Setup

A configuration string is used to define the operation of the pump. The value entered in this string select the Water Meter type.

The configuration string is displayed whenever power is applied to the pump.

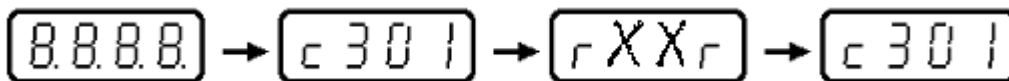

In the example above, the configuration string is "301". Only the last digit in this string is significant.



Refer to *Section 9 – Wiring & Connection Drawings* for additional information on wiring the water meter inputs.

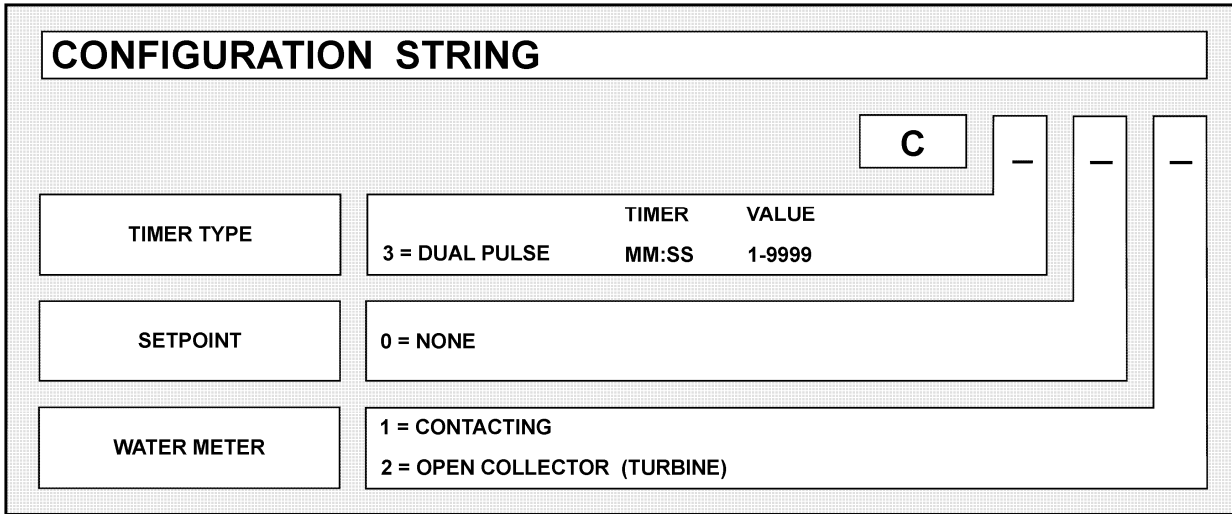

**Example:** 'c302' is a Dual Pulse timer that accepts an open collector (Turbine) water meter input.

If you are unfamiliar with the settings described here, completely read section 3 then return here.



TIP



Follow this procedure to reconfigure the software.

1. Remove power from the pump (by unplugging it) for a minimum of 5 seconds.
2. With the pump unplugged, press and hold [BLEED COUNT] and plug the pump back in.
3. Continue to hold [BLEED COUNT]. The pump will go through the normal power-up sequence:
  - All of the display elements are illuminated for 1 second.
  - The configuration number (e.g., c301) is displayed for 1 second.
  - The software revision number is displayed as "r X X r" for 1 second.

This sequence is displayed as follows:

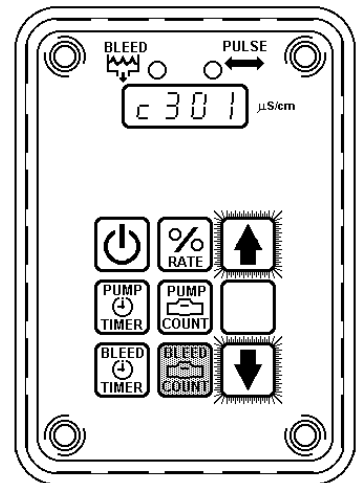
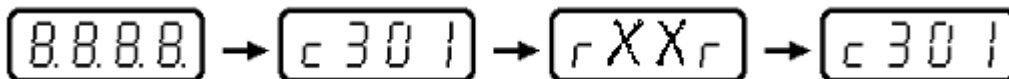

4. Continue to hold [BLEED COUNT]. The display will show the configuration value (e.g., 'c301') constantly.
5. Continue to hold [BLEED COUNT]. Press [UP] to increase the configuration value (e.g., 'c301' to 'c302'). Press [DOWN] to lower the displayed value (e.g., 'c302' to 'c301').
6. Upon releasing [BLEED COUNT] the new configuration is stored and the pump resets.
7. Observe the power-up sequence and verify that the configuration value (e.g., 'c301') appears as set in step 5.



NOTE

Timer values are reset to factory defaults with reconfiguration. Re-check all settings after reconfiguration.

### 3.2.1 K-Factor Setup

If the pump configuration string is set to c302 then a K-Factor is required to convert the pulse received into gallons or liters.



#### Follow this procedure to set the K-Factor:

1. Remove power from the pump (by unplugging it) for a minimum of 5 seconds.
2. With the pump unplugged, press and hold [PUMP COUNT] and plug the pump back in.
3. Continue to hold [PUMP COUNT]. The pump will go through the normal power-up sequence:
  - All of the display elements are illuminated for 1 second.
  - The configuration number (e.g., c301) is displayed for 1 second.
  - The software revision number is displayed as "r X X r" for 1 second.This sequence is displayed as follows:

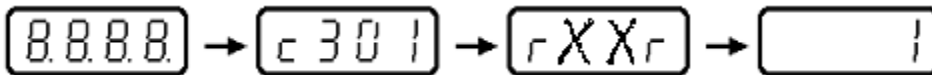
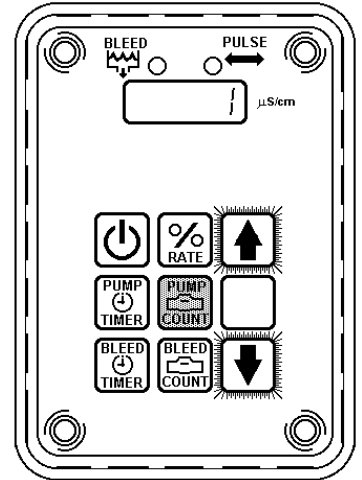

4. Continue to hold [PUMP COUNT]. The display will show the K-Factor value (e.g., '1') constantly.
5. Continue to hold [PUMP COUNT]. Press [UP ARROW] to increase the K-Factor value by 1.
6. Continuing to hold [PUMP COUNT] and [UP ARROW] will cause the K-Factor to increase by factors of 10.
7. Continuing to hold [PUMP COUNT] and [UP ARROW] for more than 10 cycles will cause the K-Factor to increase by factors of 100.
8. The setup is the same with the [DOWN ARROW]. Single presses will lower the K-Factor by 1. Continuous pressing and holding the [DOWN ARROW] will decrease the K-Factor by 10, then by 100 after 10 cycles if you continue to hold down the [PUMP COUNT] and [DOWN ARROW].
9. Upon releasing the keys, the new configuration is stored and the pump continues with normal operation.



**The K-Factor translates the pulses generated by the flow meter into gallons or liters (depending on your setting). When you configure the Pulse Timer value setting you are specifying the number of pulses per gallon or liter. For example, if your water meter has a "K" factor of 991 (on the gallons scale) it will generate 991 pulses for every gallon of fluid that flows past it. In this case you would set the "K" factor value to 991. You would then set the pump or bleed count value in gallons.**

### 3.2.2 Priming the pump

The first time you use the pump you will need to prime the pump. Use the following procedure:



**If the air bleed valve assembly is being used, a return line (tubing) should be securely connected and routed back to the storage tank. To avoid possible injury from chemicals do not attempt to prime using a bleed valve without installing a return line.**

1. Press and hold [ON/STANDBY] for 5 seconds to enter the **Forced On Run** mode.

The display will read 100 and the pump will begin to reciprocate.

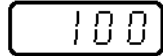

2. Watch the intake tubing for evidence of liquid coming from the feed tank (refer to *Figure 6*).
3. Once flow is seen coming out of the pump through the discharge tubing with no bubbles present, the pump is primed and is ready to be placed in an operational mode.
4. Press [ON/STANDBY] to enter the **Off** (Standby) mode.
5. Press [ON/STANDBY] a second time to enter the normal operating mode.

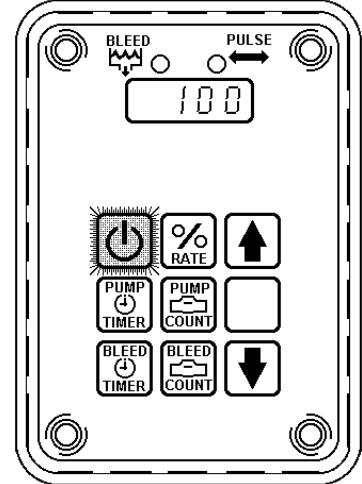

## 3.3 Programming the Pump

### 3.3.1 Rate

The Rate setting determines the pump's stroke rate. Rate is measured in percentage of stroking frequency (typically 125 strokes/min).

The factory default is 100%.



**Follow this procedure to configure your stroke rate.**

1. Press and hold [RATE] to view the current stroke rate percentage.
2. While holding [RATE], press [UP] to increase the rate value. Press [DOWN] to lower the displayed rate.
3. Upon releasing [RATE] the new percentage is stored in long term memory and takes effect immediately.

While you are in the **Forced On-Run** mode, the only item you can change that takes effect immediately is stroke rate.



**Should you make a change to the stroke rate while the controller is in the Forced On mode, the new rate will not take effect until you are in the Forced On - Run or Control mode.**

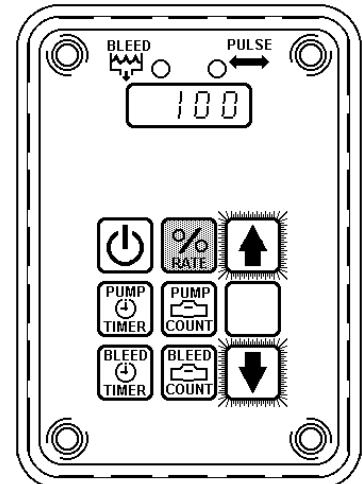

### 3.3.2 Pump Count

The PUMP COUNT setting is used to specify the number of water meter pulses (or gallons/liters if a “K” Factor has been set) to accumulate before running the pump for the length of the time specified in the PUMP TIMER setting.

For example: If the PUMP COUNT value is set to 10 and the PUMP TIMER value is set to 00:30 then the pump will run for 30 seconds upon receiving the 10<sup>th</sup> pulse (gallon/liter) from the water meter.

When the pump starts, the accumulator value is cleared (set to zero). The pump will continue to accumulate water meter pulses while the pump is running up the PUMP COUNT setting.

The factory default is 10.



**Follow this procedure to configure your Pump Count setting.**

1. Press and hold [PUMP COUNT] to view the current setting.
2. While holding [PUMP COUNT], press [UP] to increase the count value. Press [DOWN] to decrease the displayed value.
3. Upon releasing [PUMP COUNT] the new value is stored in long-term memory and takes effect immediately.



NOTE

**Should you make a change to the Count while the controller is in the Forced On or Forced On-Run mode, the new value will not take effect until you are in the Control mode.**

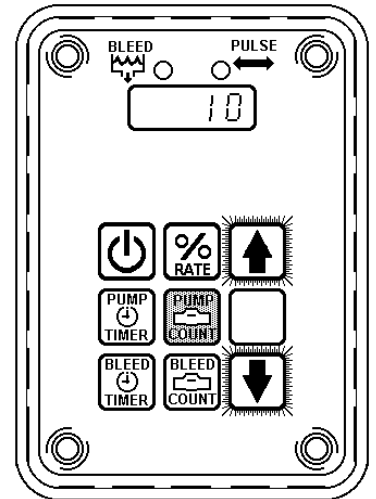

#### 3.3.2.1 Count Special Case

If the PUMP COUNT setting is set to 0, the associated timer (PUMP TIMER) will run continuously.

### 3.3.3 Pump Timer

The Pump Timer is used to set the length of time that the pump will inject a chemical.

The Pump Timer value is displayed in a minutes and seconds format (MM:SS).

The factory default is 01:30 (1 minute and 30 seconds).



TIP

**A time value always has the colon character ‘:’ displayed.**



**Follow this procedure to configure your PUMP TIMER.**

1. Press and hold [PUMP TIMER] to view the current setting in a minutes/seconds format.
2. While holding [PUMP TIMER], press [UP] to increase the displayed value. Press [DOWN] to lower the displayed value.
3. Upon releasing [PUMP TIMER] the new value is stored in long term memory and takes effect immediately.



NOTE

**Should you make a change to the Pump Timer while the controller is in the Forced On or Forced On-Run mode, the new duration will not take effect until you are in the Control mode.**

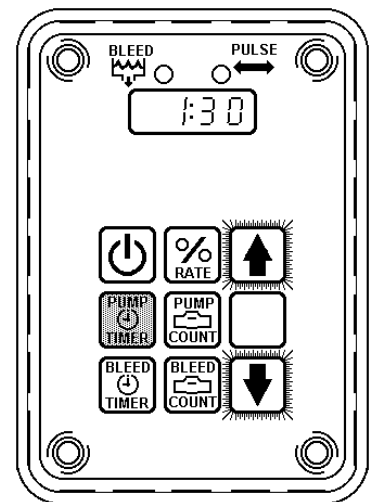

TIP

**If the Pump Timer value is set to 00:00 the pump will not operate.**

### 3.3.4 Bleed Count

The BLEED COUNT setting is used to specify the number of water meter pulses (or gallons/liters if a “K” Factor has been set) to accumulate before activating the bleed relay for the length of the time specified in the BLEED TIMER setting.

For example: If the BLEED COUNT value is set to 10 and the BLEED TIMER value is set to 00:30 then the pump will run for 30 seconds upon receiving the 10<sup>th</sup> pulse (gallons/liters) from the water meter.

When the bleed relay activates, the accumulator value is cleared (set to zero). The pump will continue to accumulate water meter pulses while the bleed relay is active up the BLEED COUNT setting.

The factory default is 10.



**Follow this procedure to configure your BLEED COUNT setting.**

1. Press and hold [BLEED COUNT] to view the current setting.
2. While holding [BLEED COUNT], press [UP] to increase the count value. Press [DOWN] to lower the displayed value.
3. Upon releasing [BLEED COUNT] the new value is stored in long-term memory and takes effect immediately.



**Should you make a change to the Count while the controller is in the Forced On or Forced On-Run mode, the new duration will not take effect until you are in the Control mode.**

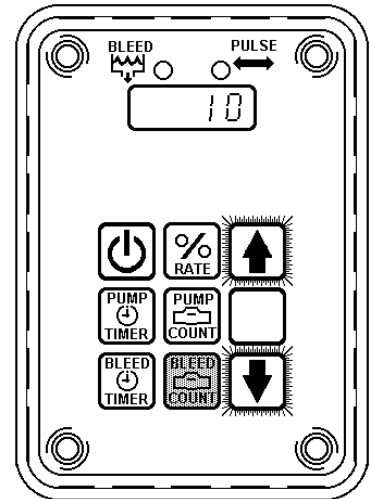

#### 3.3.4.1 Count Special Case

If the BLEED COUNT setting is set to 0, the associated timer (BLEED TIMER) will run continuously.

### 3.3.5 Bleed Timer

The Bleed Timer is used to set the length of time that the bleed relay will activate.

The Bleed Timer value is displayed in a minutes and seconds format (MM:SS).

The factory default is 01:30 (1 minute and 30 seconds).



**A time value always has the colon character ‘:’ displayed.**



**Follow this procedure to configure your BLEED TIMER.**

1. Press and hold [BLEED TIMER] to view the current setting in a minutes/seconds format.
2. While holding [BLEED TIMER], press [UP] to increase the displayed value. Press [DOWN] to lower the displayed value.
3. Upon releasing [BLEED TIMER] the new value is stored in long term memory and takes effect immediately.



**Should you make a change to the Bleed Timer while the controller is in the Forced On or Forced On-Run mode, the new duration will not take effect until you are in the Control mode.**

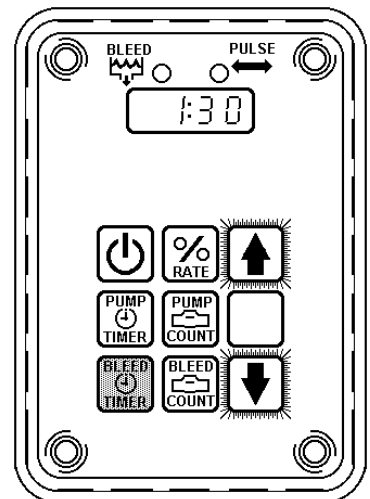

**If the Bleed Timer value is set to 00:00 the bleed relay will not operate.**

## 3.4 Operating Modes

The Series WT pump has been developed with four operating modes.

- **Off** (Standby)
- **Control**\*
- **Forced - On**
- **Forced - On / Run**

\* When the **Control** mode is active, there are four possible sub-modes:

- Bleed & Feed
- Feed
- Bleed
- No Flow

Each of the modes and sub-modes of operation will be covered in this section.

### 3.4.1 Off (Standby)

**Off (Standby)** represents the mode that the pump is in when it is not cycling (i.e. discharging fluid) and the relay output is disabled. To place the pump in the **Off (Standby)** mode press [ON/STANDBY].



**While it is the intent of the manufacturer to ship all pumps in the Off (Standby) mode, it is possible that the pump/controller could be in an active mode. Be sure that you take all safety precautions.**

Press [ON/STANDBY] to access this mode.



When the controller is in the **Off (Standby)** mode the following occurs:

1. The display reads 'OFF'
2. The pump is stopped.
3. The relay output is disabled.

Press [ON/STANDBY] to exit this mode.

### 3.4.2 Control

**Control** is the most common mode of operation. While in this mode, the display shows the current number of counts in the Bleed and Feed accumulators. When a count setpoint has been reached, the display shows the accumulated run time for that timer. The following screen sequence is typical while the unit is accumulating counts:



**The count value is always displayed after the status word (e.g., 'BLEd'). In the above example, the Bleed accumulator has counted 1 pulse and the Feed accumulator has counted 2 pulses.**

### 3.4.2.1 Bleed & Feed

When the pump is in the **Bleed & Feed** mode, both the pump and bleed relay are active. To enter this mode, the accumulated counts have exceeded the BLEED COUNT and PUMP COUNT set points. And, both the BLEED TIMER and PUMP TIMER have not expired. The **Bleed & Feed** mode is a sub-mode of **Control**.

Press [ON/STANDBY] to access this mode.

While the controller is in the **Bleed & Feed** mode:

1. The Bleed relay is active and the Pump is turned on (discharging fluid).
2. The display will alternate between the accumulated run times (e.g., 00:03 in mm:ss format) ) every 4 seconds.

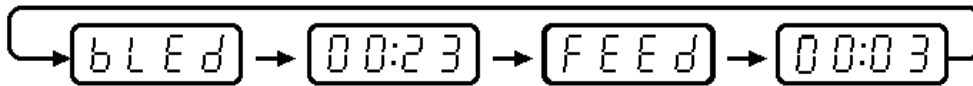

The time value is always displayed after the status word (e.g., 'BLEd'). In the above example, the Bleed relay has been active for 23 seconds and the Feed has been active for three seconds.

3. The count-down timer (run time) is incremented every second from the 00:00 start value.

The controller remains in the **Bleed & Feed** mode until:

- a) The timer for either the Bleed or Feed reaches the set value (e.g., BLEED TIMER setting).
- b) [ON/STANDBY] is pressed.
- c) Power is cycled.



While in this mode, the pump continues to accumulate pulses up to the BLEED COUNT and PUMP COUNT settings. If the count set point is reached before the timer expires, the timer will re-start immediately after it expires.

### 3.4.2.2 Bleed

When the pump is in the **Bleed** mode, only the bleed relay is active. To enter this mode, the accumulated counts must have exceeded the BLEED COUNT set point, but not the PUMP COUNT set point. Or, the PUMP TIMER must have expired while the pump was in the **Bleed & Feed** mode. The **Bleed** mode is a sub-mode of **Control**.

Press [ON/STANDBY] to access this mode.

While the controller is in the **Bleed** mode:

1. The Bleed relay is active. The Pump is turned off.
2. The display will alternate between the accumulated Bleed run time (e.g., 00:23 in mm:ss format) and the accumulated Feed count (e.g., 2) every 4 seconds.

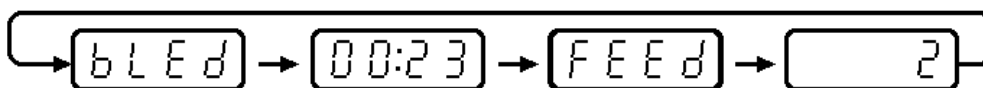

The value is always displayed after the status word (e.g., 'BLEd'). In the above example, the Bleed relay has been active for 23 seconds and the Feed accumulator has received 2 pulses.

3. The count-down timer (run time) is incremented every second from the 00:00 start value up to the BLEED TIMER set point.

The controller remains in the **Bleed** mode until:

- a) The timer for the Bleed reaches the BLEED TIMER set point.
- b) The Feed accumulator reaches the PUMP COUNT setpoint.
- c) [ON/STANDBY] is pressed.
- d) Power is cycled.

### 3.4.2.3 Feed

When the pump is in the **Feed** mode, only the pump is active (i.e., discharging fluid). To enter this mode, the accumulated counts must have exceeded the PUMP COUNT set point, but not the BLEED COUNT set point. Or, the BLEED TIMER must have expired while the pump was in the **Bleed & Feed** mode. The **Feed** mode is a sub-mode of **Control**.

Press [ON/STANDBY] to access this mode.

While the pump is in the **Feed** mode:

1. The Pump is turned on (i.e., discharging fluid). The Bleed Relay is turned off.
2. The display alternates between the accumulated Feed run time (e.g., 00:23 in mm:ss format) and the accumulated Bleed count (e.g., 2) every 4 seconds.

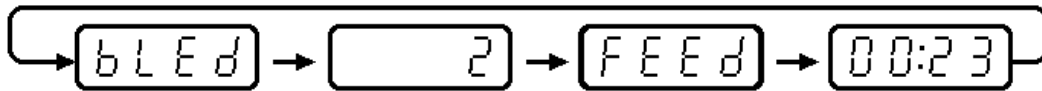

The value is always displayed after the status word (e.g., 'BLEd'). In the above example, the Bleed accumulator has received 2 pulses and the Feed has been active for 23 seconds.

3. The count-down timer (run time) is incremented every second from the 00:00 start value up to the PUMP TIMER set point.

The controller remains in the **Feed** mode until:

- a) The timer for the Feed reaches the PUMP TIMER set point.
- b) The Bleed accumulator reaches the BLEED COUNT setpoint.
- c) [ON/STANDBY] is pressed.
- d) Power is cycled.

### 3.4.3 Forced - On

In the **Forced - On** mode the bleed relay is activated and the pump operates at its maximum rate for 5 minutes. It is useful for priming the pump after replacing the chemical supply.

Press and hold [ON/STANDBY] for more than 1 second but less than 5 seconds to activate this mode.

When the controller is in the **Forced - On** mode:

1. The display reads 'On'.
2. The pump operates at its maximum rate (100%).
3. The Bleed Relay is activated.

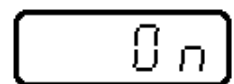

The controller exits the **Forced - On** mode when one of the following occurs:

- a) The **Forced - On** mode is active for 5 minutes.
- b) [ON/STANDBY] is pressed
- c) Power is cycled.



Upon exiting the **Forced-On** mode, the system is returned to the **Control** mode.

### 3.4.3.1 Forced - On / Run

The **Forced - On / Run** mode allows you to operate the pump at a selected frequency (RATE) with no time limit imposed. This mode is useful if you want the pump to operate without regard to the water meter input.

Press and hold [ON/STANDBY] for more than 5 seconds when in the OFF (Standby) mode to access this mode.

While the controller is in the **Forced - On / Run** mode:

1. The display shows the frequency value (Rate, e.g., 100).
2. The pump operates at a specified frequency (Rate).

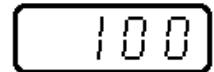

The controller exits the **Forced - On / Run** mode when [ON/STANDBY] is pressed



Upon exiting the **Forced - On / Run** mode, the system is returned to the **On/Stand-by** mode.



The **Pump Mode** is stored in **Long Term** memory. In the event the pump/controller loses power, when power is restored, the pump returns to the mode it was in at the time of the power loss.

## 3.5 Loss of Power

All water meter accumulators and timers are reset at power-up (i.e., accumulated counts and run-times will be lost).

When power is restored, the unit will return to the mode that was active at the time of the power loss with the exception of the **Forced - On** mode. If the unit was operating in the **Forced - On** mode, when power is re-applied, the unit will enter the **Forced - On** mode and operate for the full 5 minutes.

### 3.5.1 No Flow

When the Flow input detects “No Flow” (open circuit) the pump and Bleed Relay will not operate.



Pumps supplied without a flow switch include a jumper to close the circuit.

When the controller is in the **No Flow** mode the following occurs:

1. The display alternates (2 seconds) between the phrase 'No' and 'FLo'.
2. The Bleed Relay output is set to the off state.
3. The pump stops cycling.

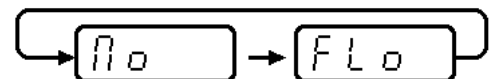

The controller will exit the **No Flow** mode when the flow input is restored. The **Forced - On** and **Forced - On / Run** modes ignore the Flow input.

## 3.6 Specifications

All pumps will conform to the following specifications:

### Unit Power:

- Operating voltage 120VAC +/- 10%, 5AMP's maximum.
- Protection, Fuse: 250VAC, 5A Slo-Blow removable (circuit board mounted).
- Cordage: 8' length 16AWG 3-Wire Domestic 120 VAC power cord set.

### High Voltage Output (Bleed Relay):

- Operating voltage: Same as supplied to unit.
- Capacity: 4AMP at 240VAC maximum.
- Protection: None. Fused at power cord.
- Status: Normally Open.
- Cordage: 6" (min) Pigtail with Female Duplex Plug.

### Flow Input:

- Input Type: Isolated Dry Contact only.
- Switching Technique: 5VDC supplied by controller.
- Sensor: None (Optional). Shorting jumper provided.
- Sensor Connector: External 1X2 Molex style with shrink over wrap.
- Minimum Pulse Width 125ms

### Water Meter Input:

- Input Type: Isolated Dry Contact or Open Collector (sinking).
- Switching Technique: 5VDC supplied by controller 50mA max.
- Sensor: None – Pigtail provided.
- Sensor Connector: External 1X3 Molex style with shrink over wrap.
- Minimum Pulse Width 125ms closed/125ms open (configuration = c301)  
2ms closed/2ms open (configuration = c302)

### User Interface:

- Display 4 Character LED (Red Characters)
- Stroke LED Green LED. Illuminated when the Solenoid pulses
- Relay LED Green LED. Illuminated when relay is on.
- Keypad Membrane style, 9 Keys: On/Standby, Up, Down and 6 Function keys.

### Enclosure:

- IP Rating IP54 (Protected against dust and splashing water)
- NEMA Rating Type 3R (Vented enclosure protected against dust, rain, sleet and ext. ice)

### Environment:

- Max Ambient 104°F (40°C)

## 3.7 Options

The following options are available:

- 240 VAC international power cord set (240 VAC international power cord and cord with stripped ends for wiring controls with relay options).
- Flow Switch
  - Flow Tee
  - Flow cap with 2-pin female molded connector. 8' cord.
  - Shuttle
- CE Approval
- Agency Approval
  - ETL/ETLC
- Flow & Pressure Range
  - @100psi = 22 or 30 GPD
  - @150psi = 6 or 12 GPD
  - All standard wet end components are available.

## 3.8 Factory Initialization

If [PUMP / TIMER], [PUMP / COUNT] and [RIGHT MIDDLE PAD] are pressed simultaneously, the controller performs a **Factory Initialization**. When the controller is in the **Factory Initialization** mode, the following occurs:

1. All factory defaults are moved from permanent memory (i.e., Flash), to long term memory (i.e., EEPROM).
2. The processor re-sets causing the program to re-execute power-up and the following sequence is displayed:

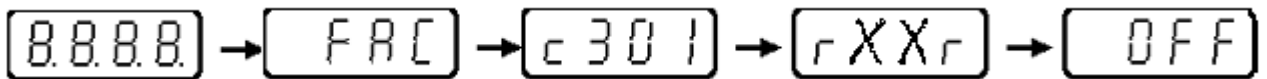

The factory initialization mode will not change the configuration setting (e.g., 'c301').



### Typical Connections

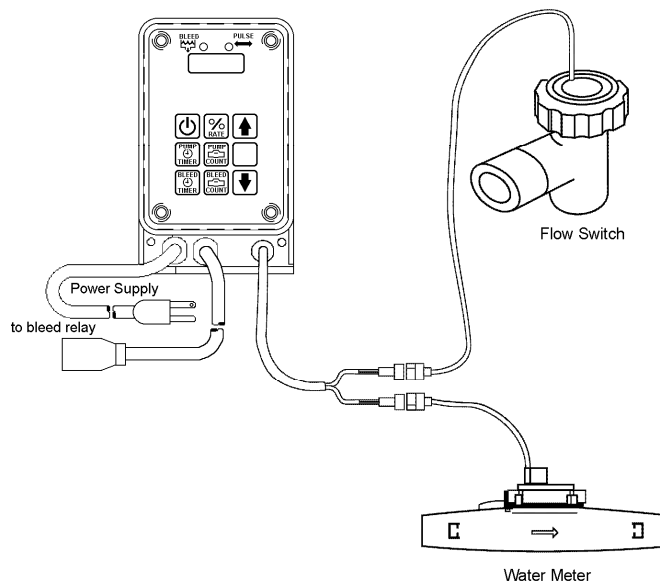

# Flow Switch & Water Meter Input Wiring

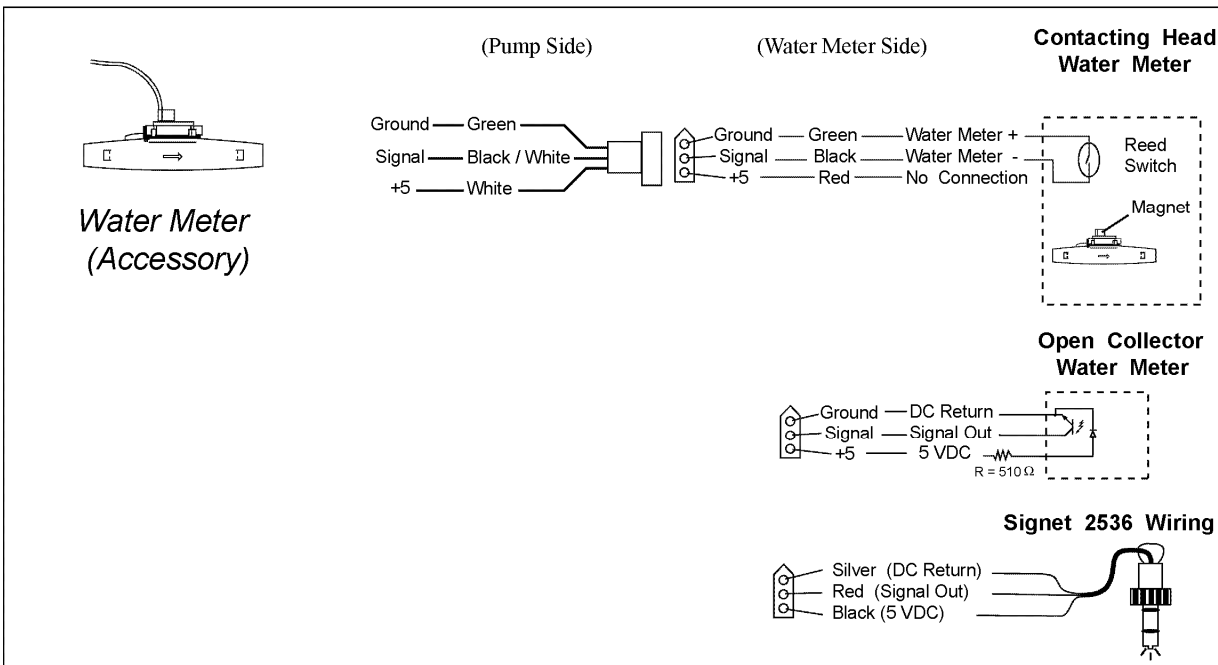
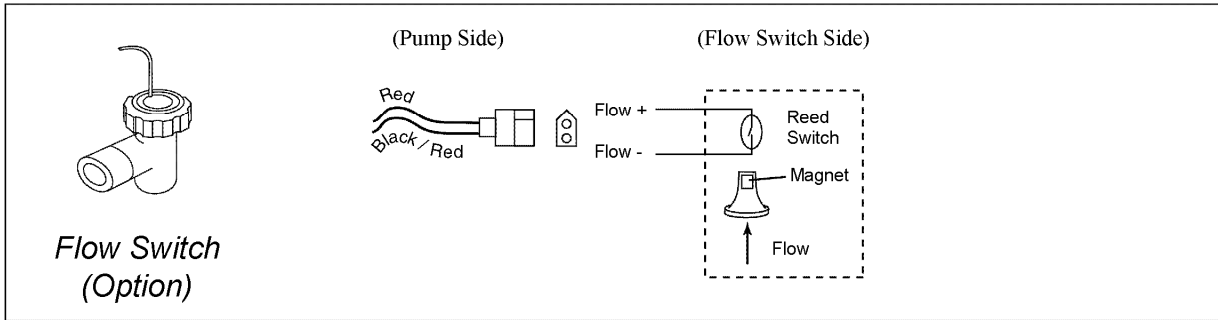

## 4. Maintenance



**BEFORE PERFORMING ANY MAINTENANCE OR REPAIRS ON CHEMICAL METERING PUMPS, BE SURE TO DISCONNECT ALL ELECTRICAL CONNECTIONS AND INSURE THAT ALL PRESSURE VALVES ARE SHUT OFF AND PRESSURE IN THE PUMP AND LINES HAS BEEN BLED OFF.**



**Always wear protective clothing, gloves and safety glasses when performing any maintenance or repairs on chemical metering pumps.**

### 4.1 Routine Maintenance

1. Routinely check the physical operating condition of the pump. Look for the presence of any abnormal noise, excessive vibration, low flow and pressure output or high temperatures [when running constantly at maximum stroke rate, the pump housing temperature can get up to 160°F (70°C)].
2. For optimum performance, cartridge valve assemblies should be changed every 4-6 months. Depending on the application, more frequent changes may be required. Actual operating experience is the best guide in this situation. Repeated short-term deterioration of valve seats and balls usually indicates a need to review the suitability of wetted materials selected for the application. Contact the supplier for guidance.
3. Check for leaks around fittings or as a result of deteriorating tubing (i.e., when standard white translucent discharge tubing is exposed to direct sunlight). Take appropriate action to correct leaks by tightening fittings or replacing components.
4. Keep the pump free of dirt and debris as this provides insulation and can lead to excessive pump temperatures.
5. If the pump has been out of service for a month or longer, clean the pump head/valve assemblies by pumping fresh water for approximately 30 minutes. If the pump does not operate normally after this “purging run”, replace the cartridge assemblies.

### 4.2 Disassembly and Assembly

#### 4.2.1 Diaphragm Removal

1. Flush pump head and valve assemblies out by running water or any other suitable neutralizing solution through the pump. Wash the outside of the pump down if chemical has dripped on the pump case.
2. Disconnect tubing or piping from the pump.
3. Remove the four pump head screws and then remove the pump head assembly.
4. Remove the diaphragm by grasping it at the outer edges and turning it counterclockwise until it unscrews from the electronic power module (EPM). Don't lose the deflection plate or diaphragm shims which are behind the diaphragm. Take note of the shim quantity (can be from 0 to 2).
5. Inspect the diaphragm if it is intended to be used again. Look for indications of the PTFE face being overstretched (localized white areas) or the elastomer on the back of the diaphragm being worn. Excessive amounts of either condition require diaphragm replacement.

## 4.2.2 Diaphragm Replacement

1. When replacing the diaphragm, it's always a good idea to replace the valve cartridges and other worn parts. A kit is available from your supplier with all parts necessary to completely rebuild your pump's wet end. All your supplier needs to know is the "KOPkit No." on your pumps nameplate to supply this kit.
2. If you kept the shims from the original diaphragm or know the original quantity, skip Step #3 (shimming the diaphragm) and go to Step #5.
3. Shimming the diaphragm
  - a) Slide the diaphragm deflection plate onto the back of the diaphragm stud, radius side towards the diaphragm.
  - b) Slide two shims onto the diaphragm stud.
  - c) Screw the diaphragm/shim assembly into the EPM unit.
  - d) Turn the diaphragm/shim assembly clockwise until the deflection plate and shims are screwed down tight against the solenoid shaft and the diaphragm stops turning.
  - e) If there is a gap between the adaptor and diaphragm, repeat the procedure removing one shim each time until the diaphragm just touches the adaptor or is slightly recessed.
  - f) Remove the diaphragm/shim assembly from the adaptor.
4. Apply grease to areas of the diaphragm that contact the deflection plate or radius on the adaptor.
5. Re-assembly the diaphragm/shim assembly.
  - a) Slide the diaphragm deflection plate onto the back of the diaphragm stud, radius side towards the diaphragm.
  - b) Slide the number of shims determined from steps 3-a through 3-e onto the diaphragm stud.
6. Screw the diaphragm/shim assembly into the EPM unit.
7. Place the pump head onto the adaptor with the flow arrows pointing up and install and tighten the four pump head screws. (Tighten the screws until the pump head pulls up against the adaptor).
8. Place the pump back into service.

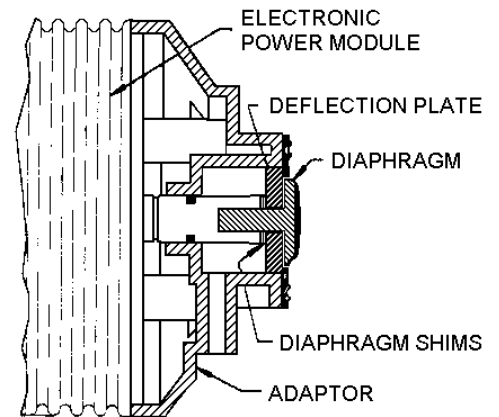

## 4.2.3 Valve Replacement

1. Flush the pump to clean any chemical from the pump head.
2. Unplug the pump and disconnect any tubing or piping.
3. Unscrew valve cartridges and discard.
4. Remove O-Rings located inside the pump head.
5. Using new O-Rings, install new valve cartridges with stamped letters reading from top to bottom and the arrow pointing in the direction of flow. Hand-tighten only, do not use wrenches or pliers. This is especially important when the pump head is SAN material.
6. Reconnect tubing or piping and reinstall the pump.

## 5. Troubleshooting

Problem	Probable Cause	Remedy
<b>Loss of chemical residual</b>	Pump setting too low	Adjust to higher setting.
	Scale at injection point	Clean injection parts with 8% muriatic acid or undiluted vinegar.
	Solution container allowed to run dry	Refill the tank with solution and prime.
<b>Too much chemical</b>	Pump setting too high	Lower pump rate.
	Chemical in solution tank too rich	Dilute chemical solution. NOTE: For chemicals that react with water, it may be necessary to purchase a more dilute grade of chemical direct from your chemical supplier.
	Siphoning of chemical into well or main line	Test for suction or vacuum at the injection point. If suction exists, install an anti-siphon valve.
<b>Leakage at tubing connection</b>	Worn tube ends	Cut off end of tubing (about 1") and then replace as before.
	Chemical attack	Consult your seller for alternate material.
<b>Failure to pump</b>	Leak in suction side of pump	Examine suction tubing. If worn at the end, cut approximately an inch off and replace.
	Valve seats not sealing	Clean valve seats if dirty or replace with alternate material if deterioration is noted.
	Low solution level	Solution must be above foot valve.
	Diaphragm ruptured	Replace diaphragm as shown in the <i>Maintenance</i> section. Check for pressure above rated maximum at the injection point. NOTE: Chemical incompatibility with diaphragm material can cause diaphragm rupture and leakage around the pump head.
	Pump head cracked or broken	Replace the pump head as shown in the <i>Maintenance</i> section. Make sure fittings are hand tight only. Using pliers and/or wrenches can crack the pump head. Chemical incompatibility can cause cracking and subsequent leakage.
	Pump head contains air or chlorine gas	After turning off all pressure lines, following all normal safety precautions, disconnect discharge tubing and install a bleed valve assembly.
	Breakdown or disconnection of wiring	Connect wiring properly. Check fuse or circuit breaker.
	Voltage drop	Take measures after investigation of cause.
	Malfunction of electronic control board	Contact supplier.
	Solenoid Over Temperature	Move product to lower temperature environment. Reduce duty cycle.

Problem	Probable Cause	Remedy
<b>Pump loses prime</b>	Dirty check valve	Remove and replace check valves..
	Ball checks not seating or not seating properly	Flush the check valve with fresh water or other suitable material. If this does not correct the problem, replace the check valves. Crystals can hold check valves open, therefore the valves should be replaced as needed.
	Solution allowed to run dry	Refill container with proper chemical.
<b>Fitting Leakage</b>	Loose fittings	All fittings can be <b>hand tightened</b> to prevent leakage. Clean off chemicals that have spilled on the pump.
	Broken or twisted gasket	Check gaskets and replace if broken or damaged.
	Chemical attack	Consult your pump supplier for alternate material.
<b>Pump will not prime</b>	Too much pressure at discharge	Turn off all pressure valves, loosen outlet tubing connection at the discharge point. Remove discharge valve cartridge. Dampen ball check and valve seats with a few drops of solution. When the pump is primed, reconnect all tubing connections.
	Check valves not sealing	Disassemble, loosen, clean and check for deterioration or swelling. Reassemble and wet the valve assembly.
	Suction lift height too much	Decrease suction lift or pull a vacuum on the pump discharge until the pump is primed.
	Pump equipped with spring loaded high viscosity valves	Loosen discharge valve to aid in priming, take necessary safety precautions, or apply vacuum to pump discharge.
<b>Bleed LED / Relay stays on</b>	BLEED COUNT set to 0	Set BLEED COUNT to non-zero value.
	Input Over-pulse	The pump is receiving BLEED COUNT pulses before the BLEED TIMER expires. Either increase BLEED COUNT or decrease BLEED TIMER.
<b>Bleed LED / Relay will NOT turn on</b>	Not receiving pulses from water meter.	Check the water meter wiring.
	Water meter pulse too narrow.	Change configuration to c302 (2ms pulse width).
<b>Pump LED flashes regardless of count</b>	Pump count set to 0	Set pump count to non-zero value.
	Input over pulse	The pump is receiving pump count pulses before the pump timer re-fires. Either increase pump count or decrease pump timer.
<b>Pump LED will not turn on</b>	Not receiving pulses from water meter.	Check the water meter wiring.
	Water meter pulse too narrow.	Change configuration to c302 (2ms pulse width).

## 6. Error Codes

Error codes are displayed whenever the pump recognizes a condition that will prevent it from operating properly. Upon detection the code is displayed for approximately 2 seconds and then the pump automatically resets. This process repeats until the problem is corrected.

Code	Definition	Cause	Description	Solution
E200	Internal Processor Error	Processor/Clock Defect	The processor's clock is not generating regular interrupts.	Cycle Power. If problem does not clear, contact Technical Services.

If the problem cannot be corrected, it is possible to override the error code and operate the pump manually.



### Manual Pump operation procedure:

1. While the error code displays (e.g. E200) press and release the [ON/STANDBY] key.  
The pump will reset to the **Off** (Standby) mode.
2. Press and hold the [ON/STANDBY] key for 5 seconds. The pump will display the stroke rate percentage value (e.g. 100) and cycle at the set frequency. Refer to *Section 3.5.3.1 Forced - On / Run* for further information.

